

SANYO**LA1140****FM IF System for Car Radio****Overview**

The LA1140 is an IF system IC designed for FM car stereo receivers. It features versatile muting characteristics and allows receiver designers to realize the muting performance according to their design concept. Since the muting characteristics can be varied with a switch or a semi-fixed resistor, DX-Local switching will be accomplished with ease.

Functions

- IF amplification/limiter
- Quadrature detector
- AF preamplifier
- AFC output
- Signal meter output
- AGC output
- Muting bandwidth
- Muting under weak signal strength

Features

- Versatile muting
 - a) When muting operation is performed under a weak signal strength, an attenuation slope of the audio output against the input signal strength variations can be set at any given value.
 - b) Maximum muting attenuation can be selected to be approximately 6 to 40 dB.
 - c) Input signal strength level which actuates the muting circuit can be set freely.
- High limiting sensitivity (25 dB μ typ. with muting off) provides a fine quieting characteristic.
- High S/N (78 dB typ.)
- Low distortion (0.05% typ.) available if used with double-tuned circuits.
- Good AMR (63 dB typ. with 6 stages of differential IF amplifiers).
- Signal meter drive output proportional to the input signal strength in dB (suitable to control multiplex IC LA3370).
- Clamped ($\pm V_{BE}$) AFC output, bandwidth adjustable.
- Delayed AGC output for front end circuit.
- Small space factor due to single-ended package employed.
- 3 mm pitch of pin terminals permitting ease-to-write PC board pattern.

Package Dimensions

unit : mm

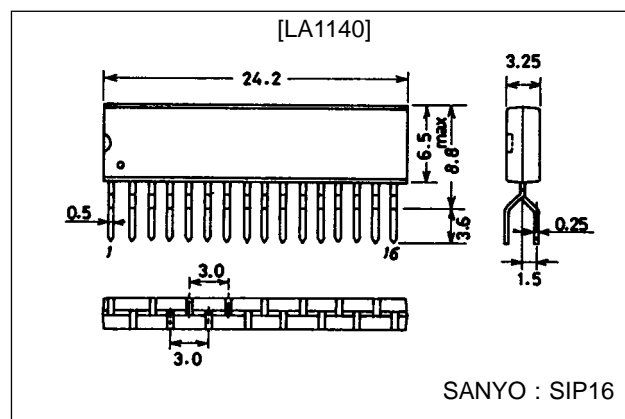
3020A-SIP16

Specifications

Maximum Ratings at Ta = 25°C

| Parameter | Symbol | Conditions | Ratings | Unit |
|-----------------------------|---------------------|------------|-------------|------|
| Maximum supply voltage | V _{CC} max | Pin 12 | 16 | V |
| Maximum supply current | I _{CC} max | Pin 12 | 40 | mA |
| Allowable power dissipation | Pd max | Ta = 25°C | 640 | mW |
| | | Ta = 70°C | 460 | mW |
| Input voltage | V _{IN} | Pin 1 to 2 | ±1 | Vp-p |
| Flow-in current | I2 | Pin 2 | ±0.2 | mA |
| | I3 | Pin 3 | ±0.2 | mA |
| | I6 | Pin 6 | 2 | mA |
| Flow-out current | I5 | Pin 5 | 1 | mA |
| | I13 | Pin 13 | 2 | mA |
| | I14 | Pin 14 | 2 | mA |
| | I15 | Pin 15 | 1 | mA |
| | I16 | Pin 16 | 1 | mA |
| Operating temperature | Topr | | -20 to +70 | °C |
| Storage temperature | Tstg | | -40 to +125 | °C |

Operating Conditions at Ta = 25°C

| Parameter | Symbol | Conditions | Ratings | Unit |
|----------------------------|--------------------|------------|-----------|------|
| Recommended supply voltage | V _{CC} | | 8 | V |
| Operating voltage range | V _{CC} op | | 7.5 to 16 | V |

Operating Characteristics at Ta = 25°C, V_{CC} = 8 V, f = 10.7 MHz, See specified Test Circuit

| Parameter | Symbol | Conditions | min | typ | max | Unit |
|---------------------------|------------------------|---|-------|------|-------|-------|
| Quiescent current | I _{CCO} | Quiescent | 15 | 21 | 27 | mA |
| Current drain | I _{CC} | V _{IN} = 100 dBμ | 20 | 25 | 30 | mA |
| Demodulation output | V _O | V _{IN} = 100 dBμ, 400 Hz 100% mod. | 200 | 260 | 320 | mVrms |
| Total harmonic distortion | THD | V _{IN} = 100 dBμ, 400 Hz 100% mod. | | 0.05 | 0.2 | % |
| Signal-to-noise ratio | S/N | V _{IN} = 100 dBμ, 400 Hz 100% mod. | 72 | 78 | | dB |
| Input limiting voltage | V _{IN} (lim) | V _O : 3 dB down, 400 Hz 100% mod. | | 25 | 29 | dBμ |
| Muting sensitivity | V _{IN} (Mute) | V14 = 2.0 V | 22 | 26 | 32 | dBμ |
| Muting attenuation (1) | Mute (ACC) | V6 = 2.0 V (22 kΩ), V _{IN} = 100 dBμ, 400 Hz 100% mod. | 10 | 15 | 20 | dB |
| Muting attenuation (2) | Mute (ACC) | V6 = 5.0 V (22 kΩ), V _{IN} = 100 dBμ, 400 Hz 100% mod. | 24 | 28 | 32 | dB |
| Muting bandwidth | BW (Mute) | V _{IN} = 100 dBμ, V14 = 2.0 V | 140 | 210 | 370 | kHz |
| AM rejection ratio | AMR | V _{IN} = 100 dBμ, FM 400 Hz 100% mod., AM 1 kHz 30% mod. | 50 | 63 | | dB |
| Muting drive output | V14-0 | Quiescent | 3.5 | 4.2 | 5.0 | V |
| Muting drive output | V14-100 | V _{IN} = 100 dBμ | 0 | 0 | 0.3 | V |
| Signal meter output (1) | V15-0 | Quiescent | 0 | 0.1 | 0.3 | V |
| Signal meter output (2) | V15-50 | V _{IN} = 50 dBμ | 0.8 | 1.4 | 2.0 | V |
| Signal meter output (3) | V15-70 | V _{IN} = 70 dBμ | 1.6 | 2.4 | 3.2 | V |
| Signal meter output (4) | V15-100 | V _{IN} = 100 dBμ | 4.5 | 5.3 | 6.0 | V |
| AGC output (1) | V16-0 | Quiescent | 3.5 | 4.1 | 4.5 | V |
| AGC output (2) | V16-100 | V _{IN} = 100 dBμ | 0 | 0.02 | 0.3 | V |
| Offset voltage (1) | V7-13 | Quiescent, pin 7 to 13 | -0.25 | 0 | +0.25 | V |
| Offset voltage (2) | V8-13 | Quiescent, pin 8 to 13 | -0.5 | 0 | +0.5 | V |

Equivalent Circuit Block Diagram

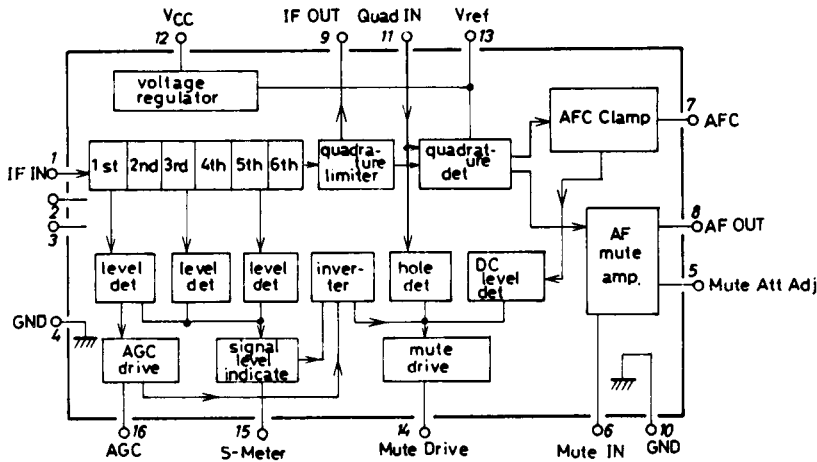

AC Test Circuit

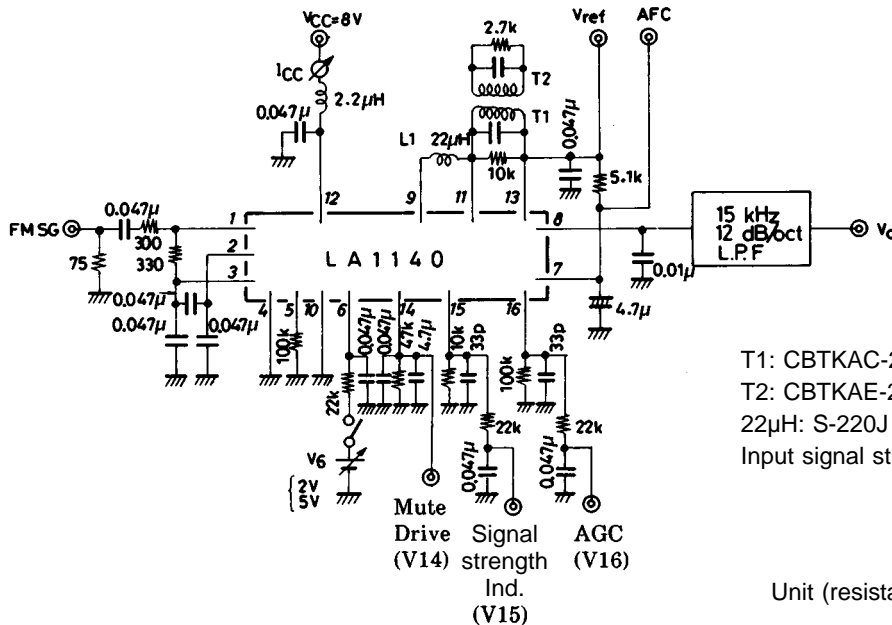

Muting Characteristic

The muting operation in the LA1140 is performed by an AF preamplifier, the gain of which varies continuously with control current, and a muting drive output circuit which supplies the control current.

The gain of the AF preamplifier decreases with increasing gain control current applied to pin 6. However, the gain does not decrease further when the control current reaches approximately 120 μA or greater. The lower limit of the gain under this condition depends upon a resistor connected between pin 5 and GND, and the higher the resistance the lower the gain (the higher the attenuation). Thus the maximum muting attenuation will be set by connecting the resistor between pin 5 and GND.

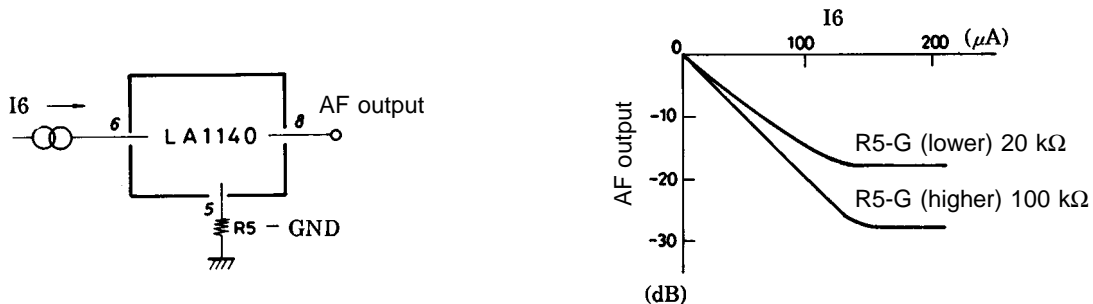

Since the muting control input pin 6 is connected to the base of the emitter grounded transistor (through a protection resistor of 500 Ω in series), the voltage between pin 6 and GND is about 0.6 V when the control current is applied. In actual cases, the muting operation is accomplished by applying a voltage drive type muting drive output (pin 14 to pin 6 through a high resistance (up to 20 kΩ)).

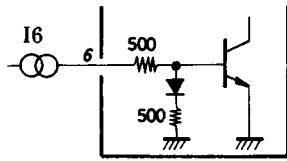

Unit (resistance: Ω)

The muting drive output comes in three types:

- 1) Hole detector output which develops a voltage when C/N (carrier-to-noise ratio) lowers under weak signal input conditions.
- 2) A reversed output of the signal strength indicating output (output at pin 15)
- 3) A bandwidth limited muting drive output which develops a voltage when the AFC output becomes higher than $\pm V_{BE}$ during tuning-off operation.

All these outputs are led to an OR circuit and the processed output is developed at pin 14. Of the above muting drive outputs, descriptions on the hole detector output and the bandwidth limited muting drive output will be omitted, since they are the same as those used in conventional quadrature detector ICs (such as LA1230, LA1231N).

The inverted output of the signal strength indication output is obtained as illustrated below.

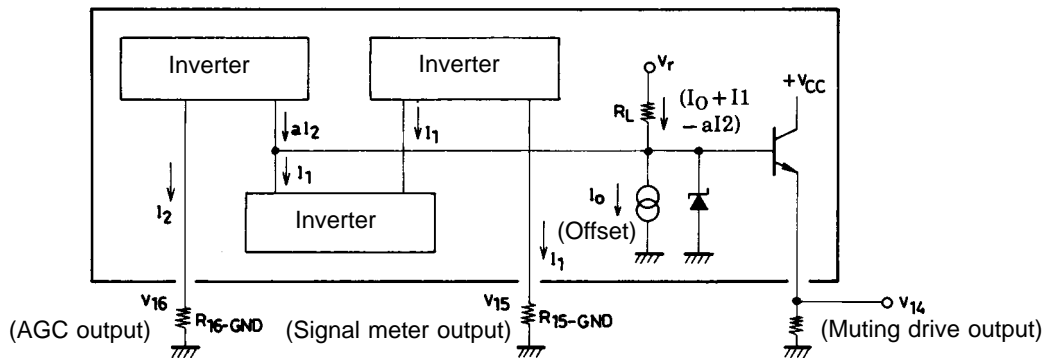

By referring to the illustration, V14 is given by the formula: $V14 = V_r - (I_0 + I1 - aI2)R_L - V_{BE}$.

Conditions are: $V_r \cong 4.9$ V, $I_0 \cong 0.2$ mA, $a \cong 2$, $R_L = 22$ kΩ, $V_{BE} \cong 0.6$ V, $I1 = V15/R15-G$, $I2 = V16/R16-G$ where V16 is a constant equal to 4.1 V (typ) for medium or lower signal input levels, where the muting drive output is required. Since the V15 increases proportionally to the increase of the input signal strength, I1 will also increase. Therefore the V14 will decrease with increasing signal strength. Thus the required muting drive output can be obtained by selecting proper values of R15-G and R16-G.

For example, the muting drive output moves toward strong input signal level if the R16-G is decreased, or the muting drive output becomes zero due to the offset current I_0 under a weak signal input condition, if the R16-G is increased to infinity (namely pin 16 is opened). However the muting drive output caused by a whole detector still exists in this case. Increasing R15-G decreases the slope of the curve for the muting drive output vs. antenna signal input level, or decreasing the R15-G increases the slope of the curve.

Furthermore, varying the value of a resistor connected between the muting drive output (pin 14) and the muting control input (pin 6) changes the value of the muting control current required to obtain the same muting drive output, accordingly the slope of the curve for muting attenuation vs. antenna signal input level is also changed. These characteristics investigated by using an actual receiver are shown on the curves below.

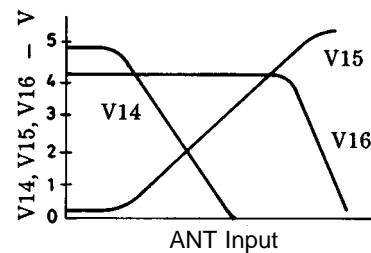

The general method to adjust the muting circuit of the LA1140 is: to set the signal input level required to actuate the muting circuit with the R16-G, to adjust the slope of the curve for the muting attenuation vs. antenna signal input with the R15-G, and to adjust the maximum muting attenuation (determined by setting the noise level at no signal) with the R5-G. The slope of the curve for the muting attenuation vs. antenna signal input level can also be adjusted by the resistor connected between pins 14 and 6 in addition to R15-G, however, selecting a resistor too high does not allow the muting control current flowing into pin 6 to reach 120 μA even through the maximum muting drive output (V14) is applied, namely the muting attenuation does not reach its maximum value. Accordingly a recommended value of the resistor between pins 14 and 6 is about 22 kΩ.

LA1140

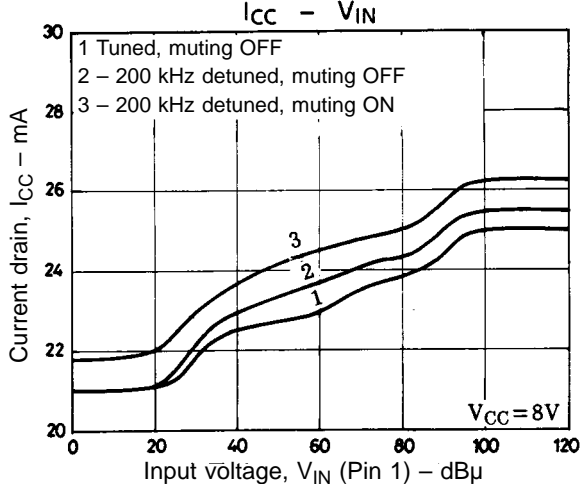
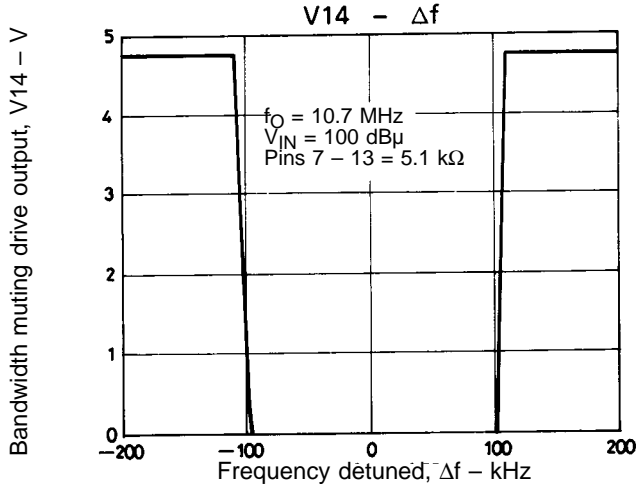
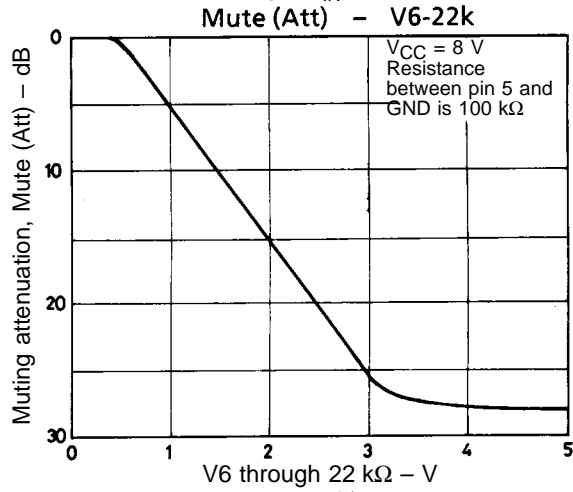
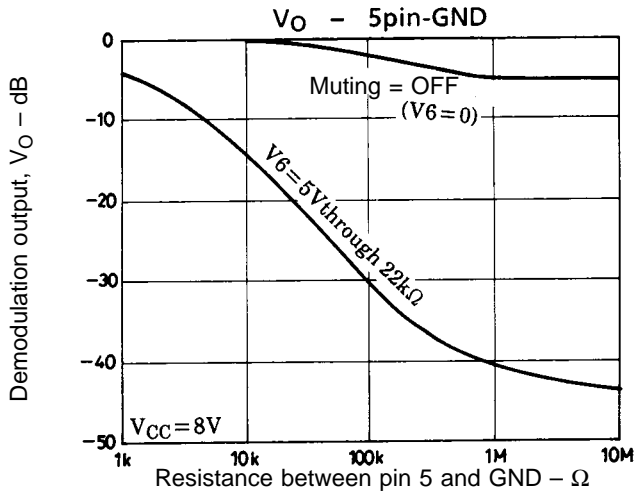
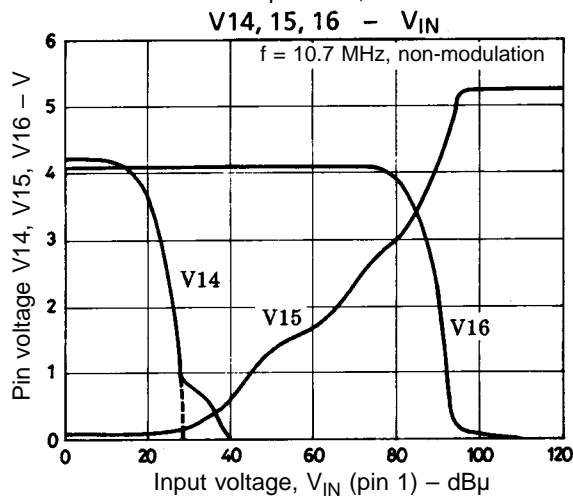
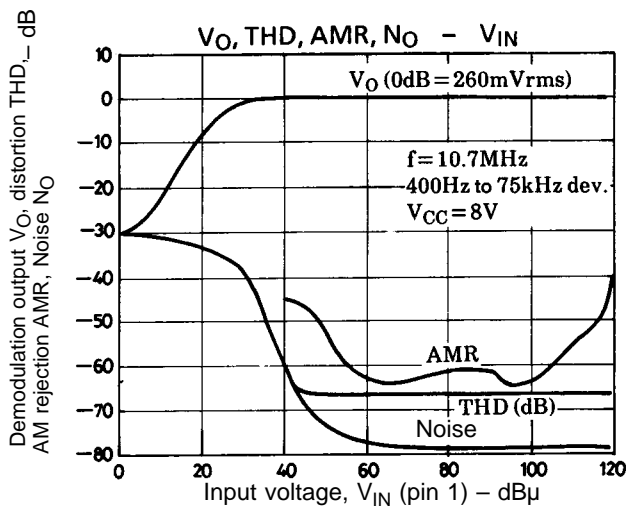
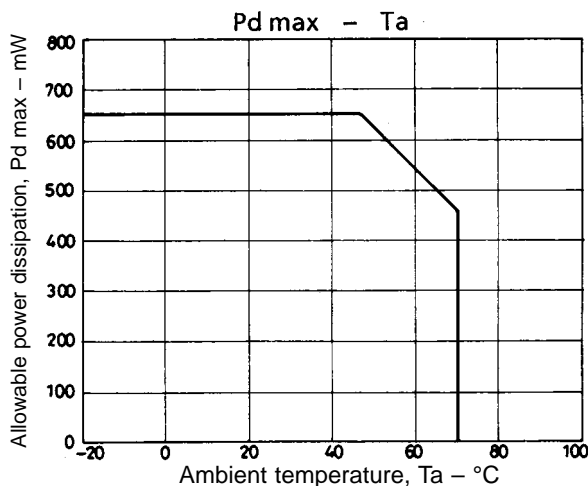
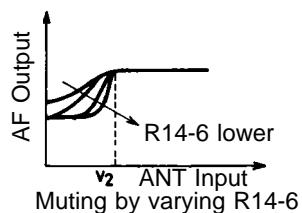
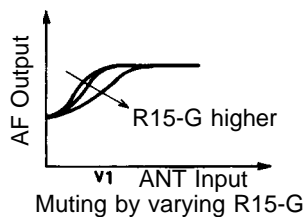

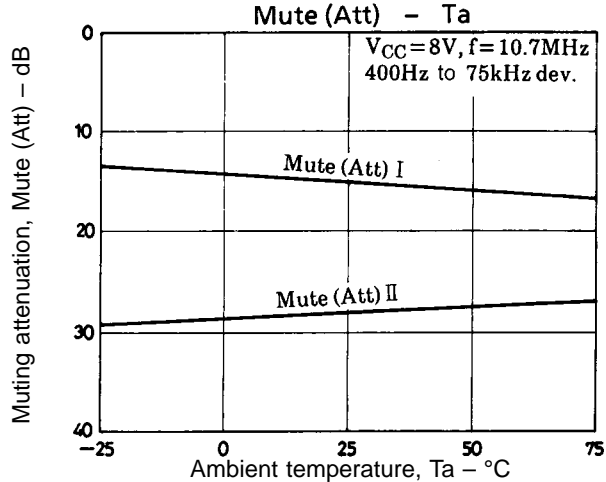
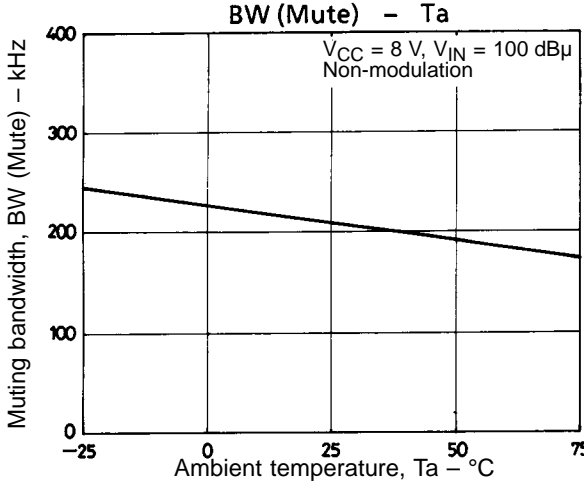
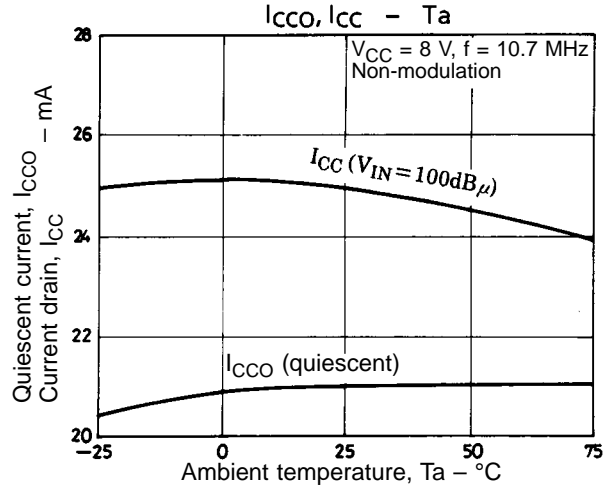
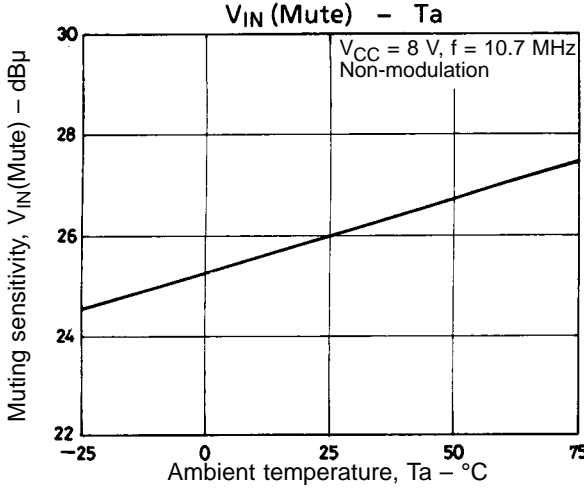
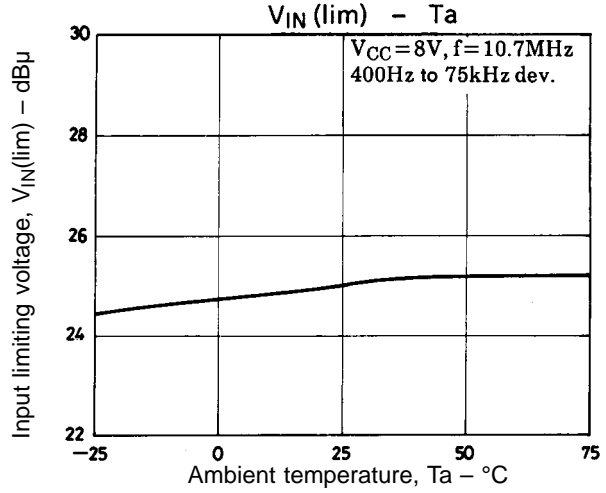
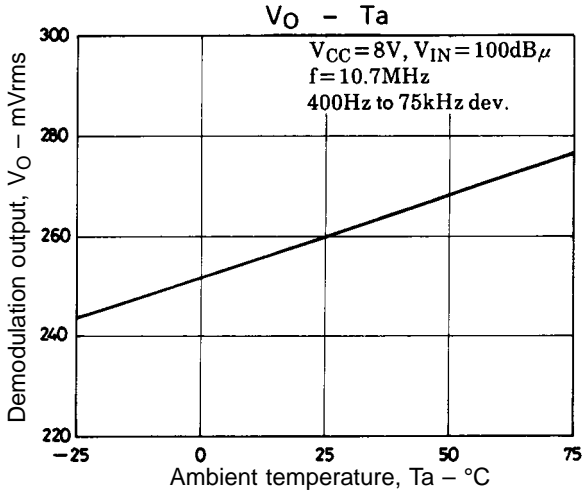
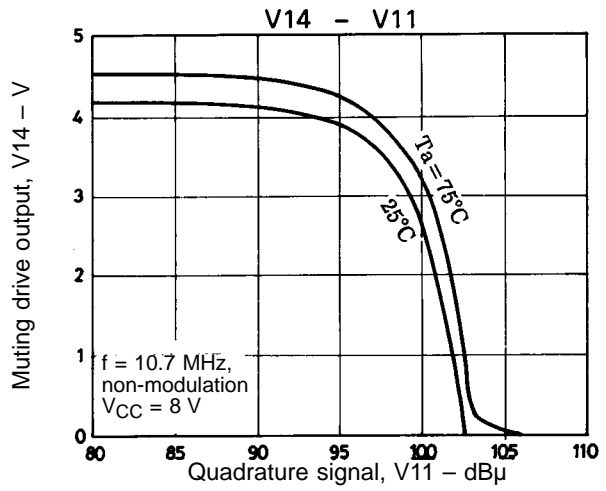
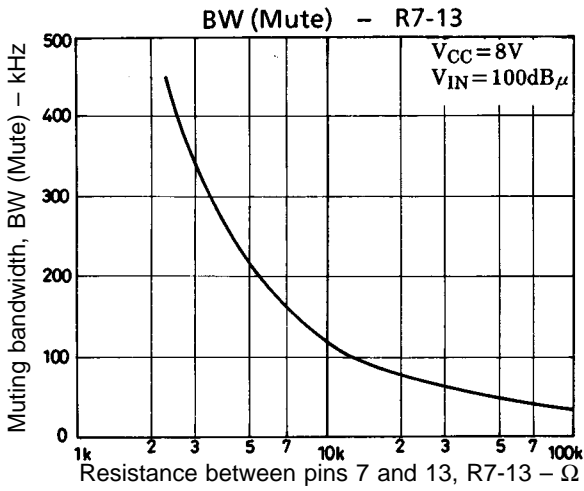

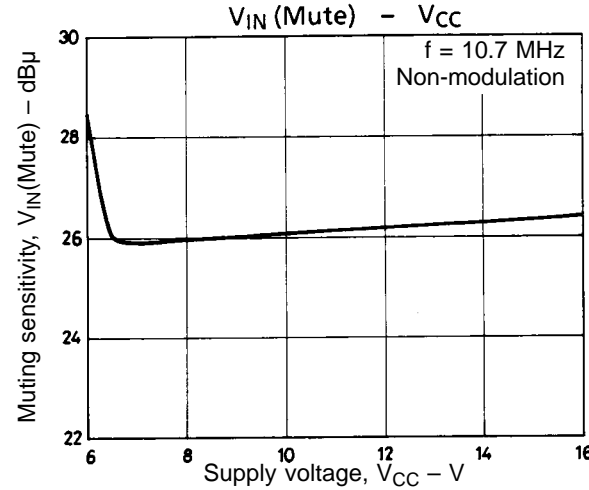
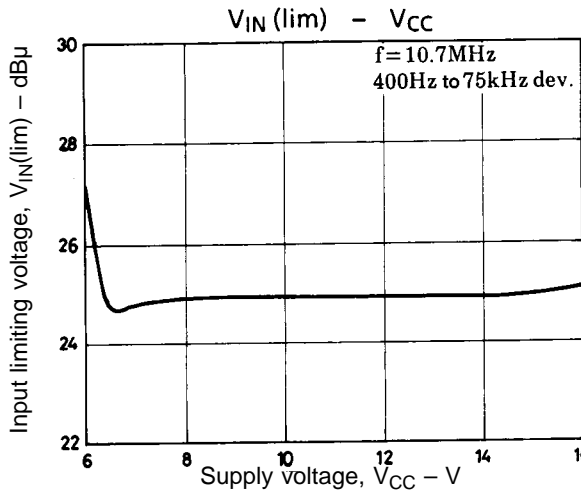
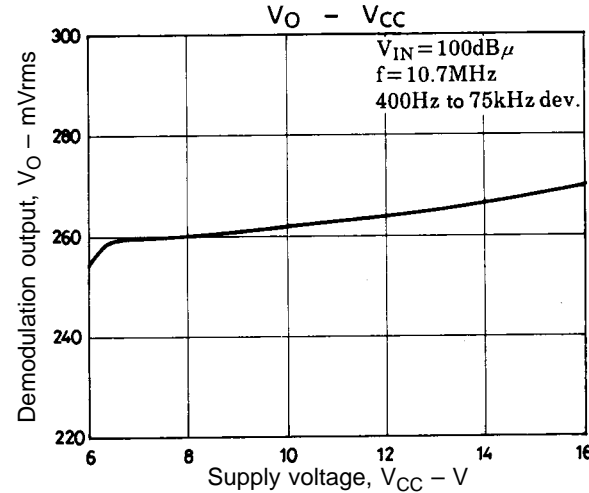
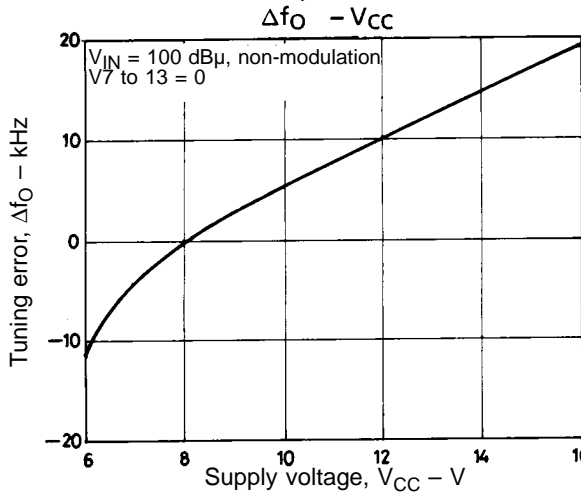
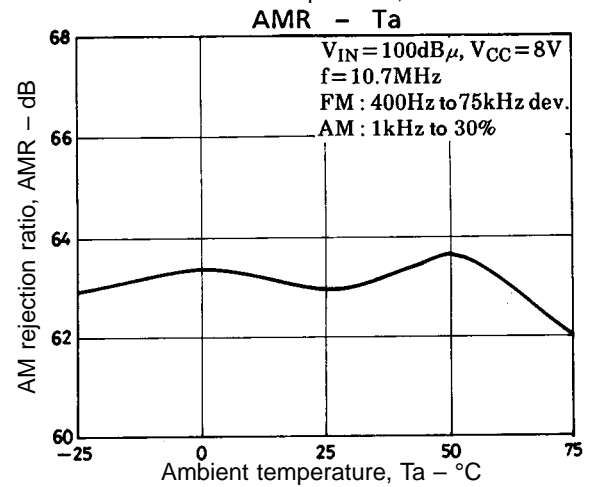
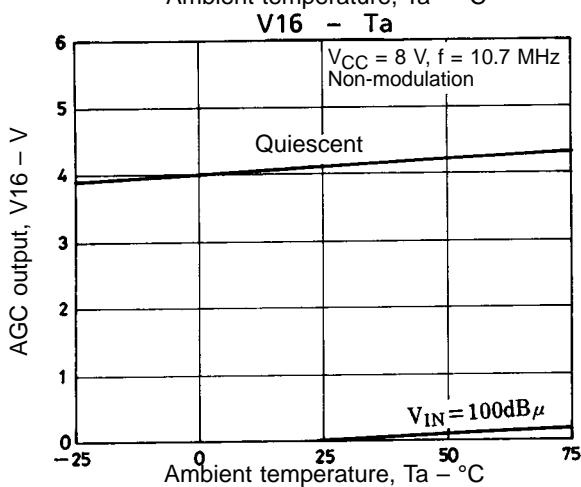
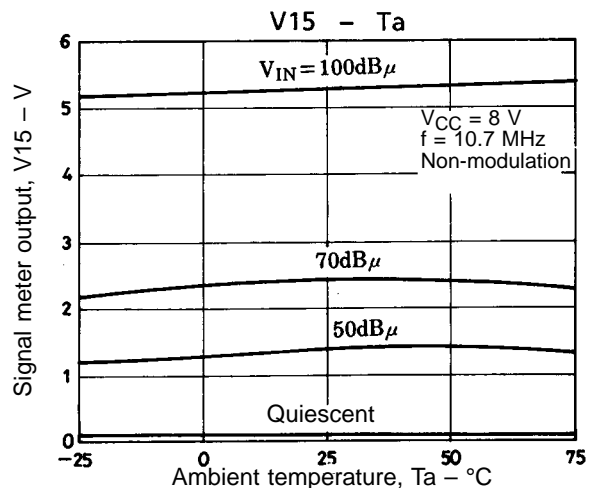
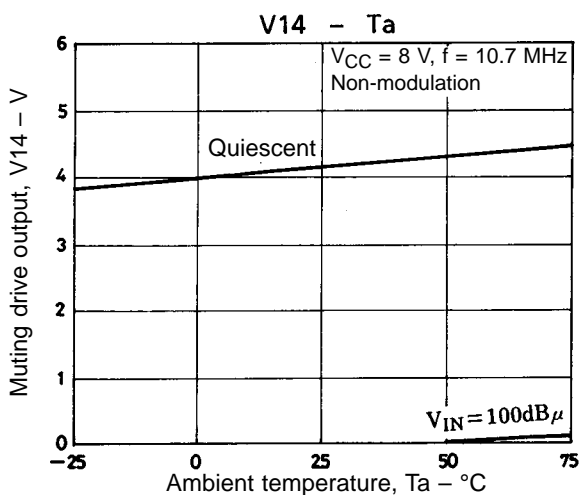

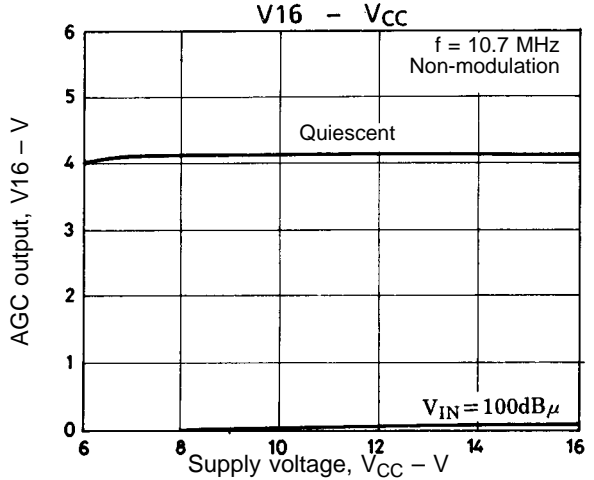
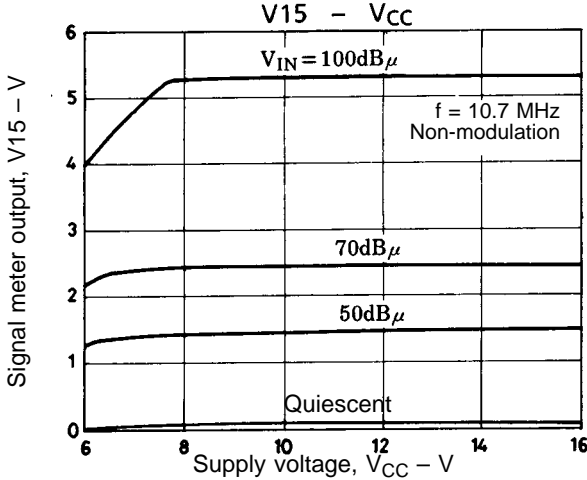
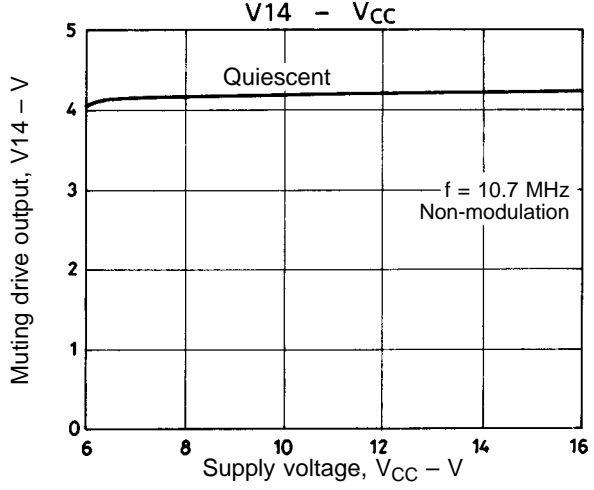
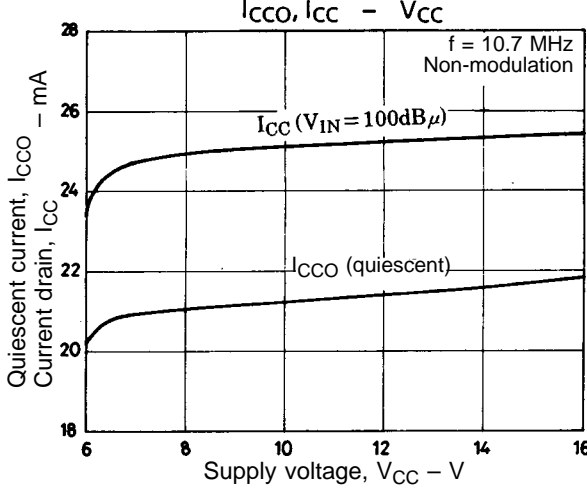
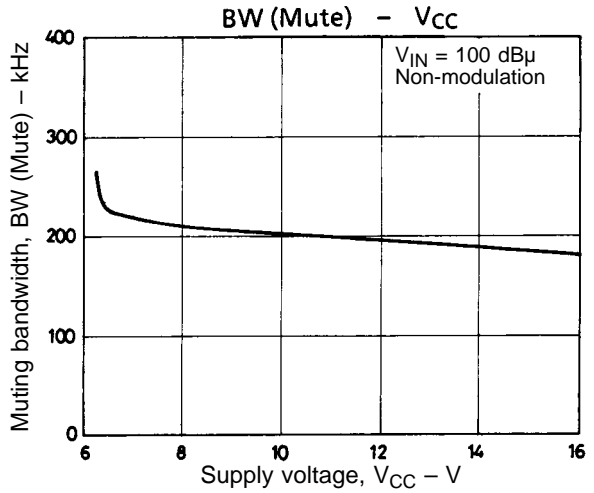
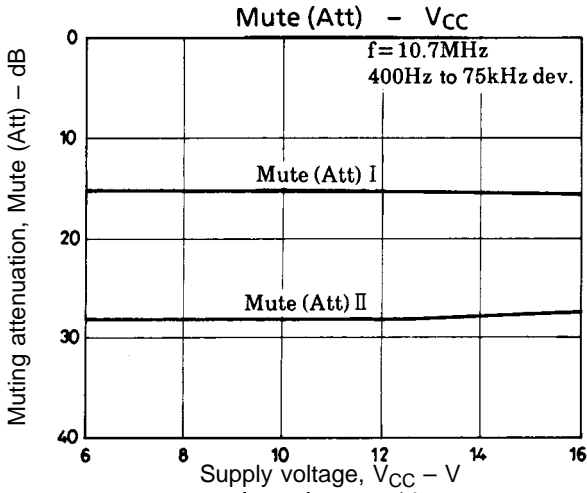
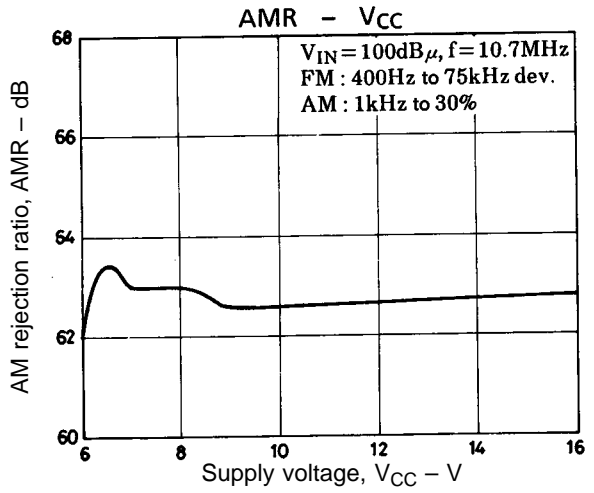
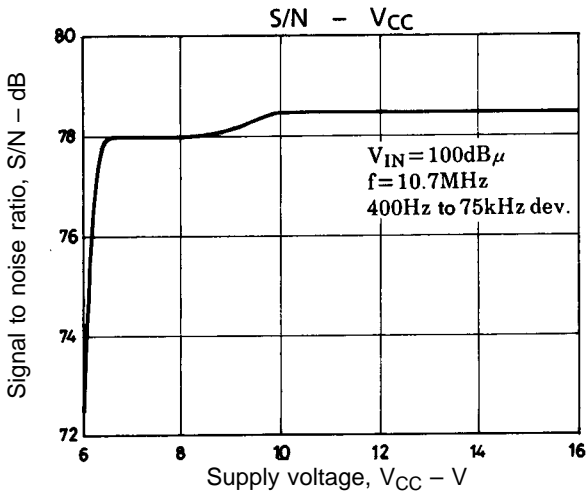

Proper cares in using LA1140

- 1) The detector transformers should be designed to develop a quadrature signal (pin 11) of higher than 175 mVrms (approximately 105 dBμ) under high antenna signal input. If the quadrature signal strength is less than 125 mVrms, the muting drive output (V14) cannot decrease to zero even in a strong signal strength. Furthermore, when the quadrature signal strength lies between 125 mV and 175 mV, the muting drive output may move from zero to plus under high temperature conditions.
- 2) When designing a PC board, special care should be given to the ground pattern layout by referring to that of the recommend PC board example as shown below.
- 3) Do not connect a capacitor directly between pin 16 and ground. If the signal intensity of IF input varies in the vicinity of 90 dBμ, the voltage at pin 16 varies. Thus, charging/discharging current flows into the capacitor and goes to the muting drive output (pin 14) through the inverter inside the IC, thereby causing the muting to malfunction.

Sample Application Circuit 1

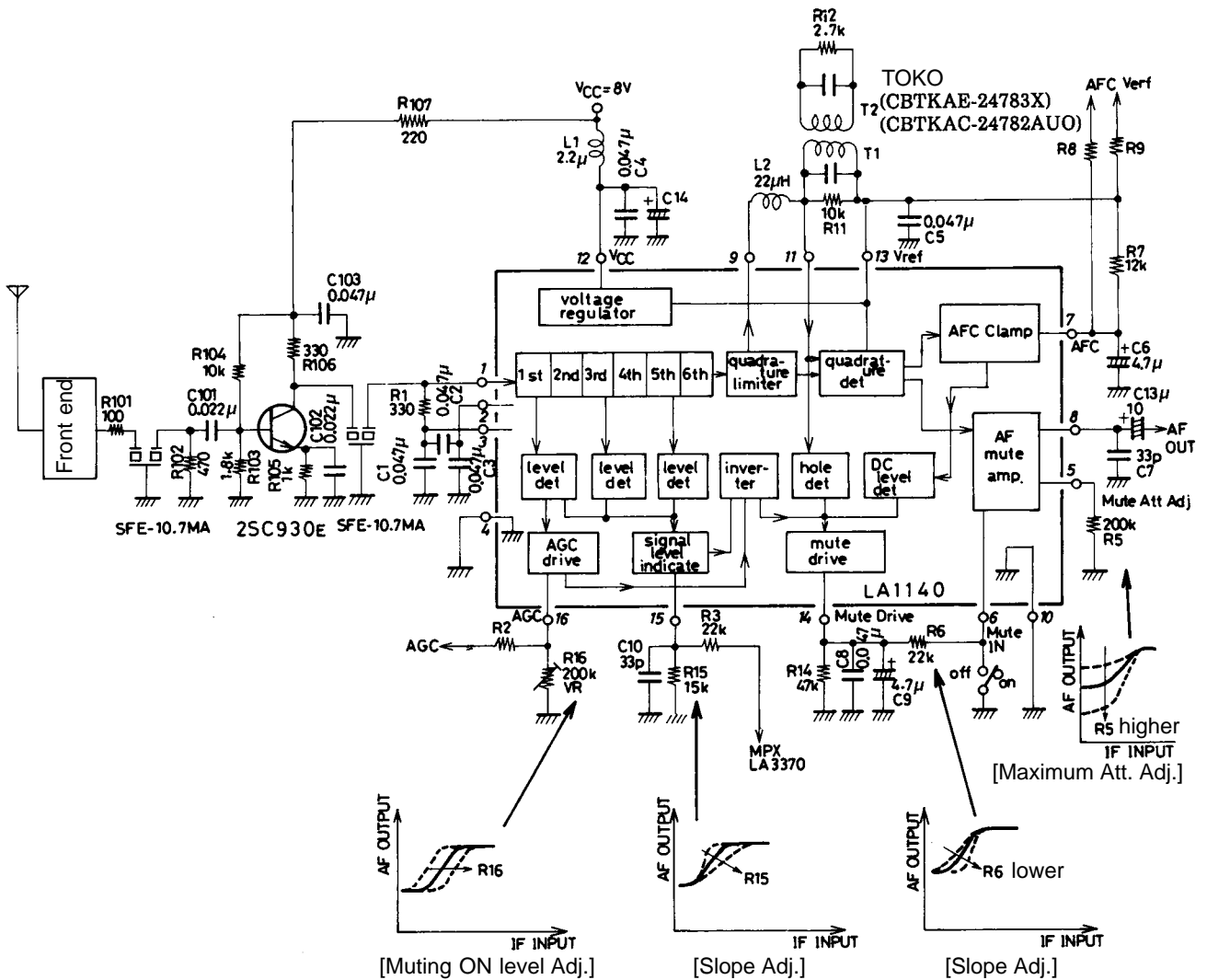

Unit (resistance: Ω, capacitance: F)

Sample Printed Circuit Pattern

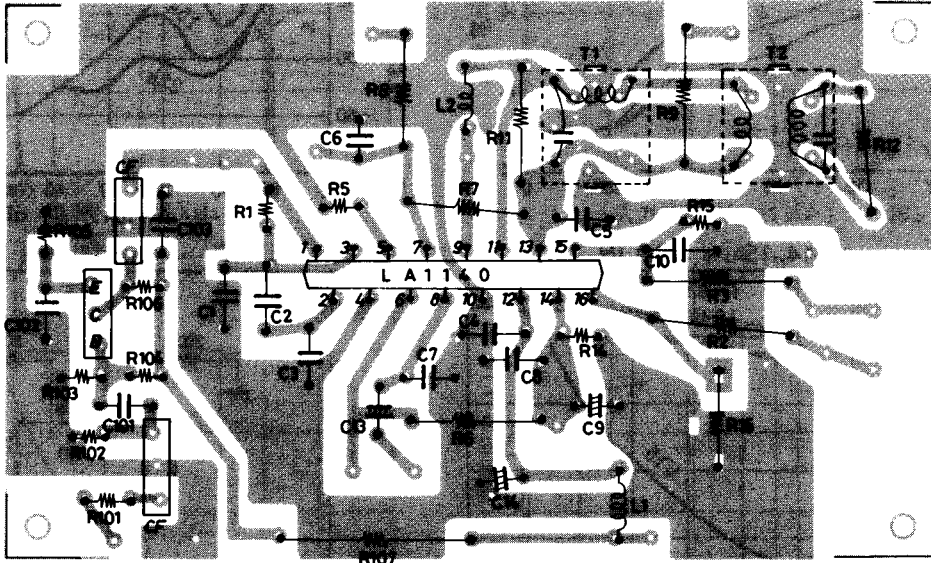

(Cu-foiled side 45 × 75 mm²)

- Variations of muting characteristics with a resistor connected between pin 16 and GND varied. (Muting threshold level adjustment)

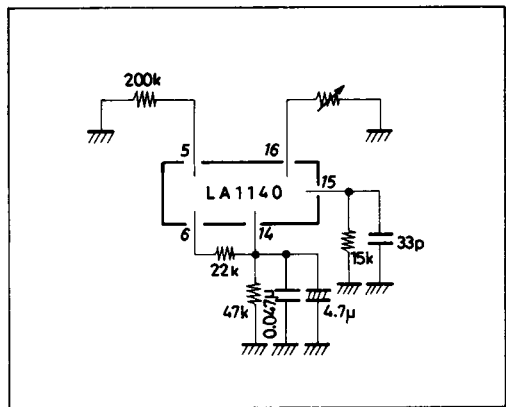
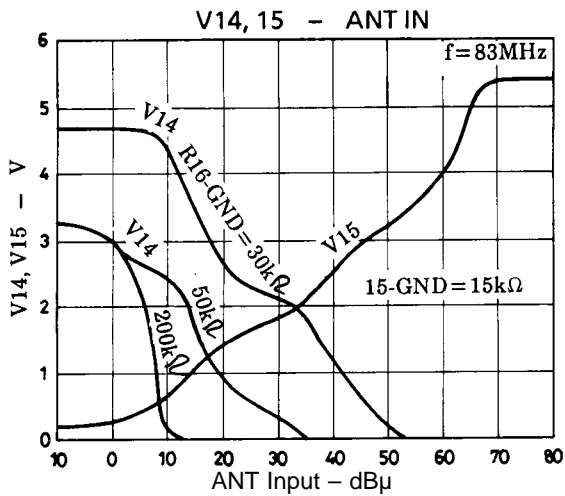
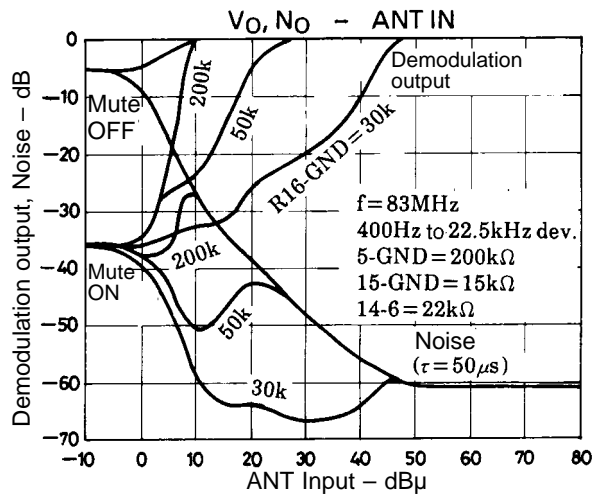

- Variation of muting characteristics with a resistor connected between pin 15 and GND varied. (Slope adjustment 1 of the curve for muting attenuation vs. antenna signal input level)

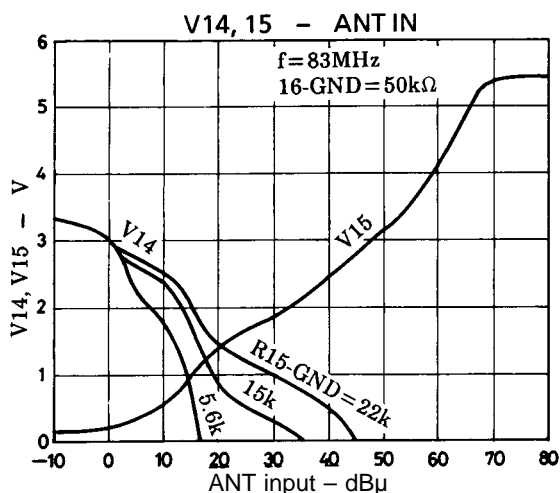

- Variations of muting characteristics with a resistor connected between pins 14 and 6 varied. (Slope adjustment 2 of the curve for muting attenuation vs. antenna signal input level)

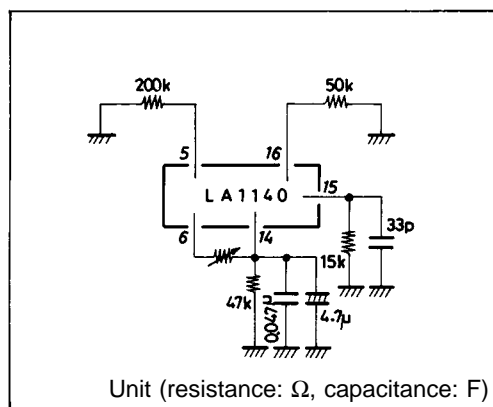
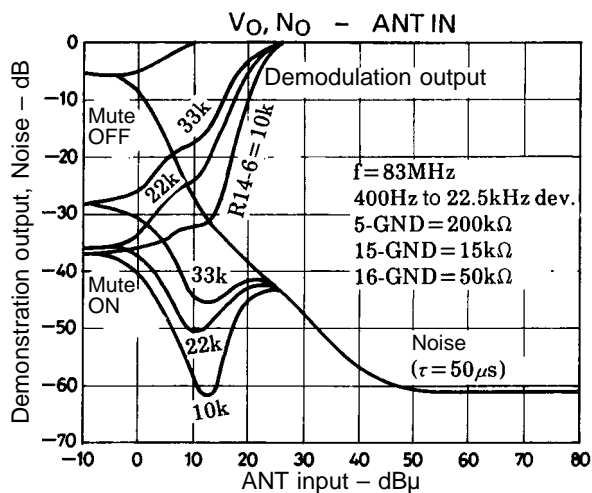
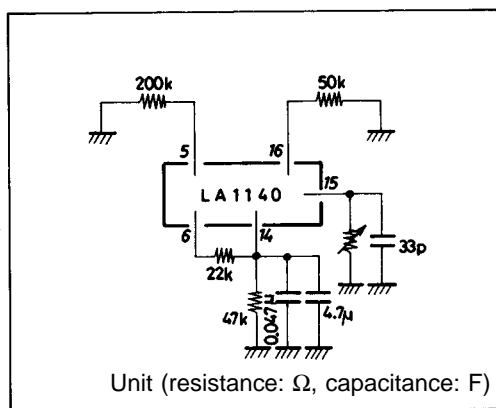
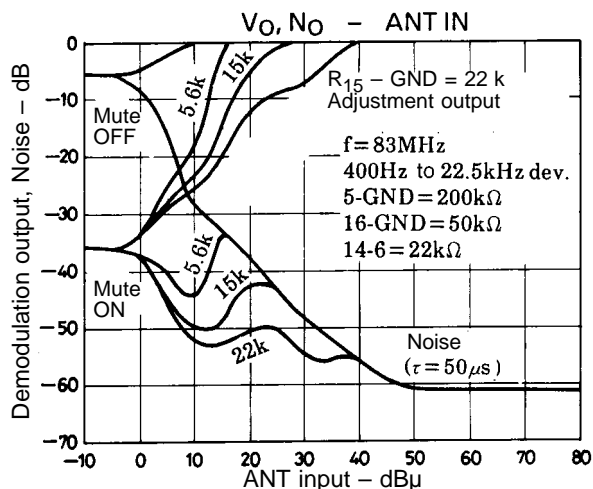
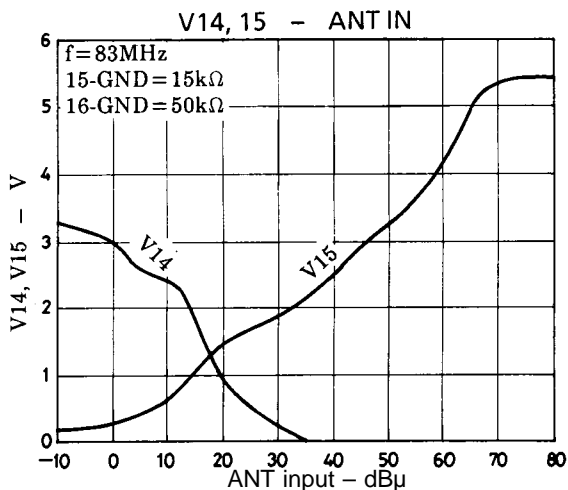

- Variations of muting characteristics with a resistor connected between pin 5 and GND varied. (Adjustment of the maximum muting attenuation)

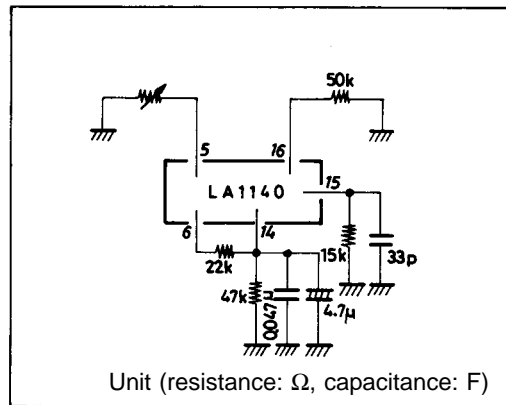
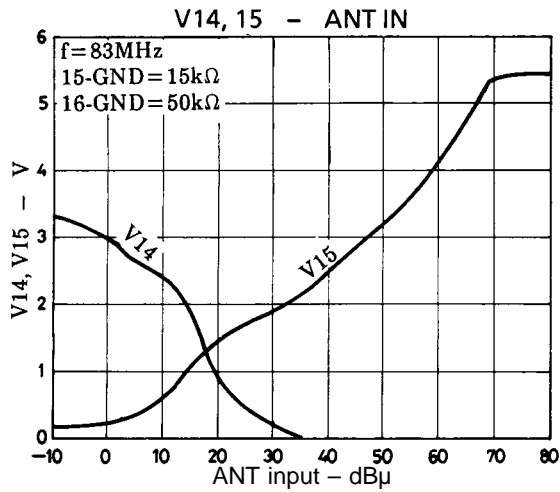
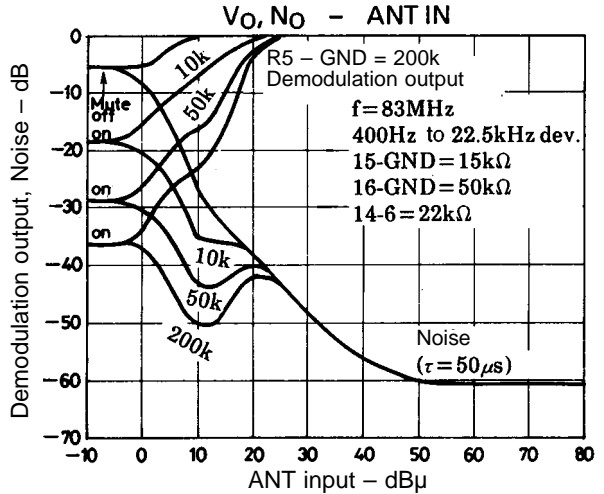

Sample Application Circuit 2

High Frequency Section of Car Radio and Car Stereo with Noise Canceller and FM Stereo Multiplexer

Almost all noise under a medium and lower input signal strength can be rejected by processing the muting characteristic of the LA1140, the stereo noise control (SNC) characteristic and the high cut control characteristic of the LA3370. These examples are as follows:

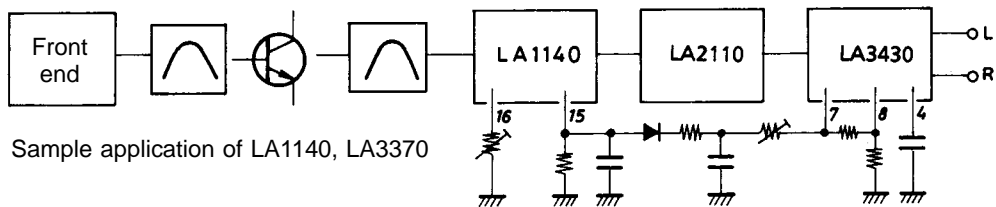

LA1140

Circuit Diagram

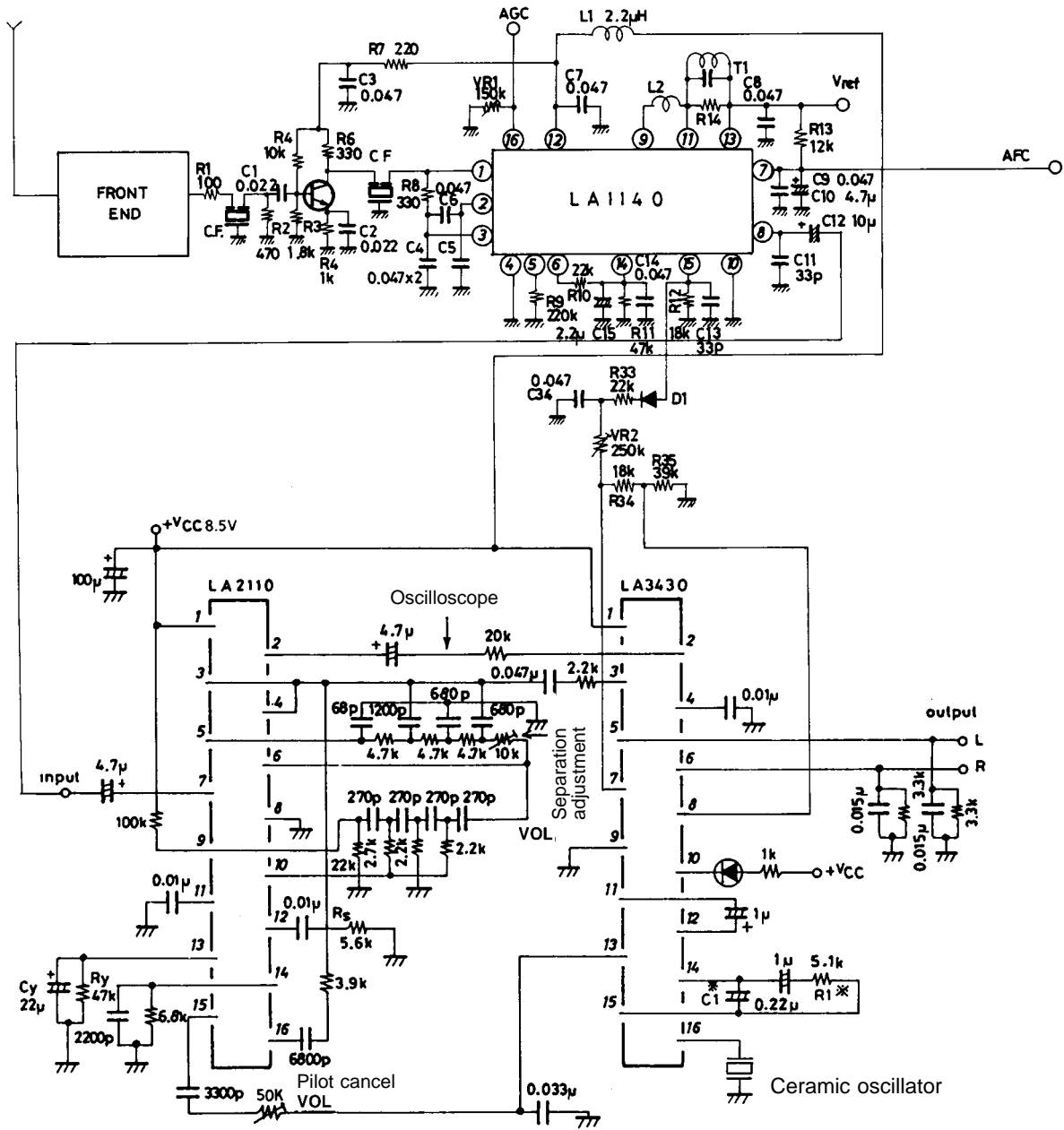

Unit (resistance: Ω , capacitance: F)

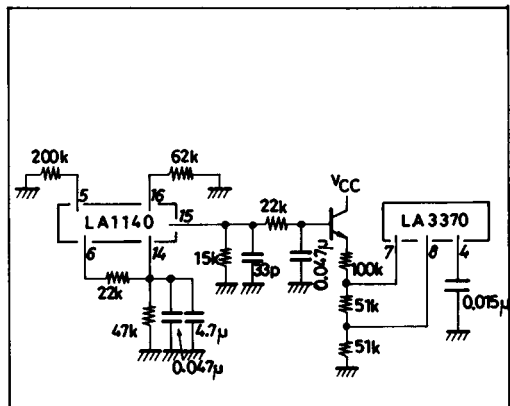
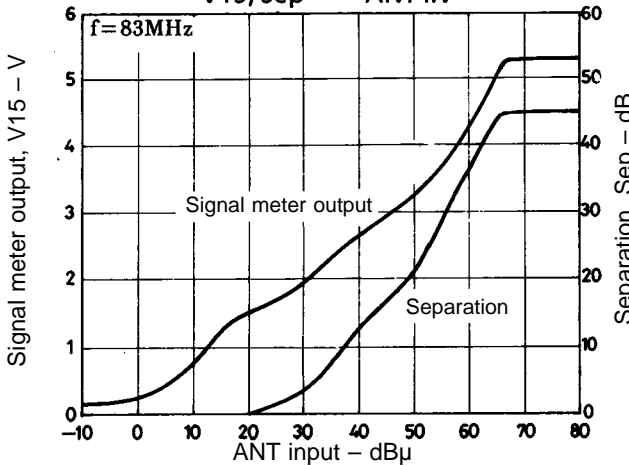
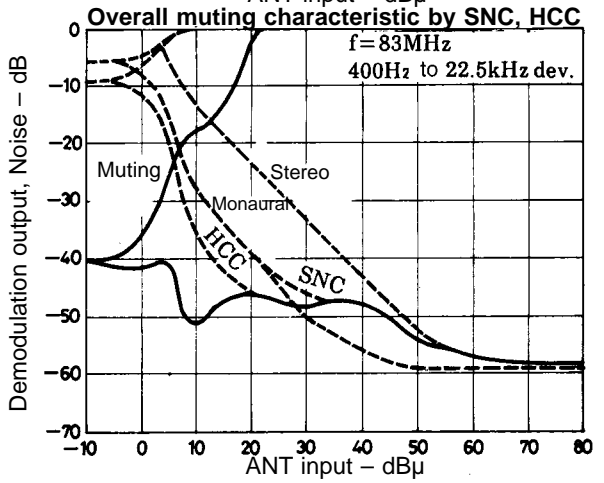
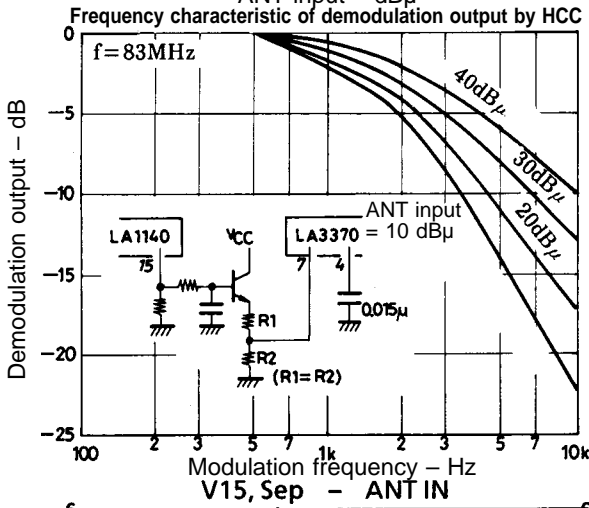
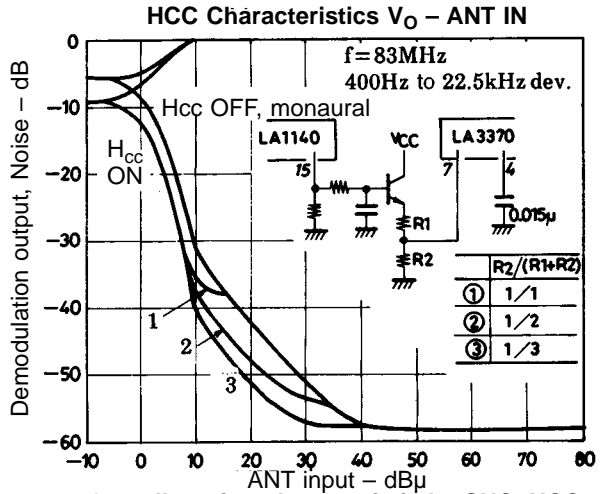
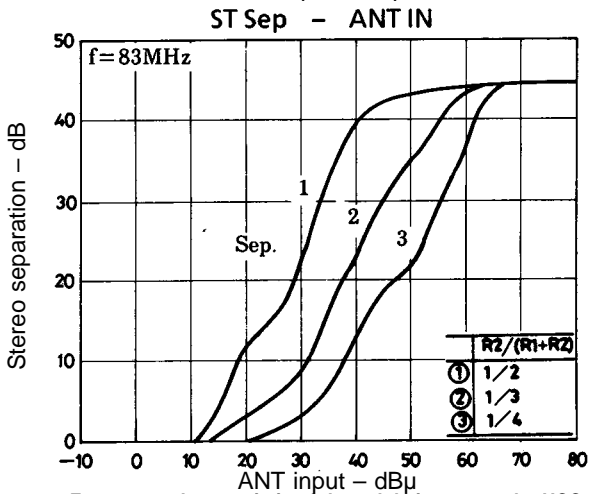
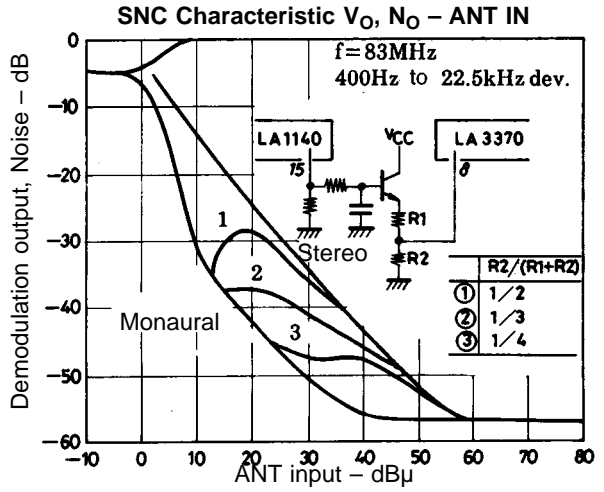
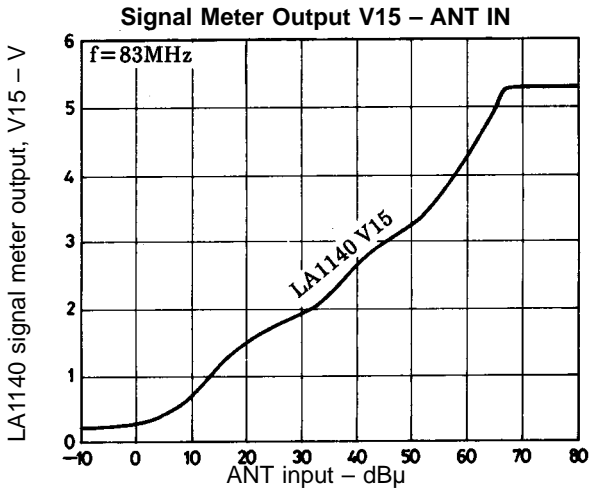

LA1140

| Item | Manufacturer | Type Number | Package | Fixed Inductor | Damping Resistor | Note |
|---------------|--------------|--|------------------------|-----------------------------|----------------------------------|------------|
| Double tuning | Toko | Pri. CBTKAC-24782AUO Sec. CBTKAE-24783X | 10 mm sq. 10 mm sq. | 22 μ H | 10 k Ω 2.7 k Ω | |
| | Sumida | Pri. 0232-702-066 Sec. 0232-702-067 | 7 mm sq. 7 mm sq. | 22 μ H | 10 k Ω 2.7 k Ω | |
| Single tuning | Toko | 119AC-14086Z MTKAC-25639Z | 7 mm sq. 10 mm sq. | 22 μ H 22 μ H | 10 k Ω 10 k Ω | |
| | Korin | 57-1011-01 59-1167-04 | 7 mm sq. 10 mm sq. | 22 μ H (22 μ H*) | 22 k Ω 5.6 k Ω | *:Included |
| | Sumida | 24M-190-268 24M-190-267 | 7 mm sq. 10 mm sq. | 22 μ H 22 μ H | 5.6 k Ω 5.6 k Ω | |
| | Sankyo | DC-11 | 7 mm sq. | (22 μ H*) | 10 k Ω | *:Included |

- No products described or contained herein are intended for use in surgical implants, life-support systems, aerospace equipment, nuclear power control systems, vehicles, disaster/crime-prevention equipment and the like, the failure of which may directly or indirectly cause injury, death or property loss.
- Anyone purchasing any products described or contained herein for an above-mentioned use shall:
 - ① Accept full responsibility and indemnify and defend SANYO ELECTRIC CO., LTD., its affiliates, subsidiaries and distributors and all their officers and employees, jointly and severally, against any and all claims and litigation and all damages, cost and expenses associated with such use:
 - ② Not impose any responsibility for any fault or negligence which may be cited in any such claim or litigation on SANYO ELECTRIC CO., LTD., its affiliates, subsidiaries and distributors or any of their officers and employees jointly or severally.
- Information (including circuit diagrams and circuit parameters) herein is for example only; it is not guaranteed for volume production. SANYO believes information herein is accurate and reliable, but no guarantees are made or implied regarding its use or any infringements of intellectual property rights or other rights of third parties.

This catalog provides information as of September, 1997. Specifications and information herein are subject to change without notice.