

Features

- **MOS COMPATIBLE**
Can be Driven Directly from many MOS Circuits
- **LOW POWER**
Excellent Readability at Only 250 μ A per Segment
- **CONSTRUCTED FOR STROBED OPERATION**
Minimizes Lead Connections
- **STANDARD DIP PACKAGE**
End Stackable
Integral Red Contrast Filter
Rugged Construction
- **CATEGORIZED FOR LUMINOUS INTENSITY**
Assures Uniformity of Light Output from Unit to Unit within a Single Category

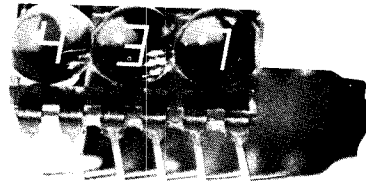
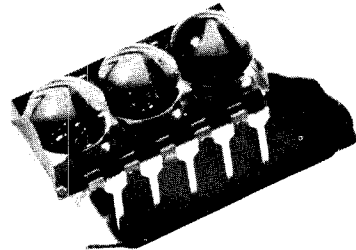

Description

The HP 5082-7430 series displays are 2.79mm (.11 inch), seven segment GaAsP numeric indicators packaged in 2 or 3 digit end-stackable clusters on 200 mil centers. An integral magnification technique increases the luminous intensity, thereby making ultra-low power consumption possible. These clusters

have the standard lower right hand decimal points. Applications include hand-held calculators, portable instruments, digital thermometers, or any other product requiring low power, low cost, minimum space, and long lifetime indicators.

Device Selection Guide

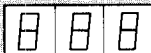
Digits per Cluster	Configuration		Part Number
	Device	Package	
2(right)		(Figure 5)	5082-7432
3		(Figure 5)	5082-7433

Absolute Maximum Ratings

Parameter	Symbol	Min.	Max.	Units
Peak Forward Current per Segment or dp (Duration < 500 μ s)	I_{PEAK}		50	mA
Average Current per Segment or dp	I_{AVG}		5	mA
Power Dissipation per Digit [1]	P_D		80	mW
Operating Temperature, Ambient	T_A	-40	75	$^{\circ}$ C
Storage Temperature	T_S	-40	100	$^{\circ}$ C
Reverse Voltage	V_R		5	V
Solder Temperature 1/16" below seating plane (t \leq 3 sec.) [2]			230	$^{\circ}$ C

NOTES: 1. Derate linearly @ 1 mW/ $^{\circ}$ C above 25 $^{\circ}$ C ambient. 2. See Mechanical section for recommended flux removal solvents.

Electrical/Optical Characteristics at $T_A=25^{\circ}$ C

Parameter	Symbol	Test Condition	Min.	Typ.	Max.	Units
Luminous Intensity/Segment or dp [3]	I_V	$I_{AVG} = 500\mu A$ ($I_{PK} = 5 mA$ duty cycle = 10%)	10	40		μcd
Peak Wavelength	λ_{PEAK}			655		nm
Forward Voltage/Segment or dp	V_F	$I_F = 5 mA$		1.55	2.0	V
Reverse Current/Segment or dp	I_R	$V_R = 5 V$			100	μA
Rise and Fall Time [4]	t_{Tr}, t_{Tf}			10		ns

NOTES: 3. The digits are categorized for luminous intensity. Intensity categories are designated by a letter located on the back side of the package. 4. Time for a 10%-90% change of light intensity for step change in current.

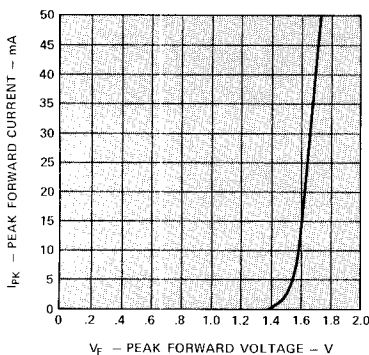

Figure 1. Peak Forward Current vs. Peak Forward Voltage

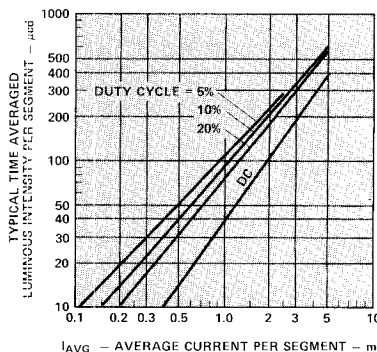

Figure 2. Typical Time Averaged Luminous Intensity per Segment vs. Average Current per Segment

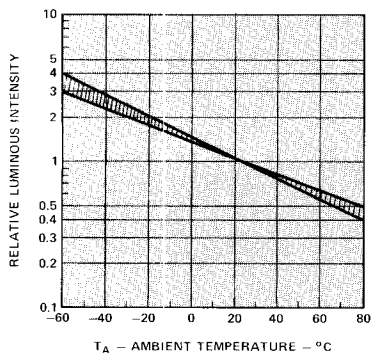

Figure 3. Relative Luminous Intensity vs. Ambient Temperature at Fixed Current Level

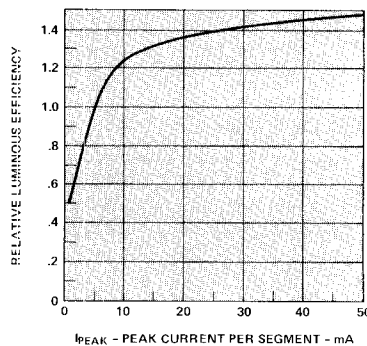

Figure 4. Relative Luminous Efficiency vs. Peak Current per Segment

Package Description

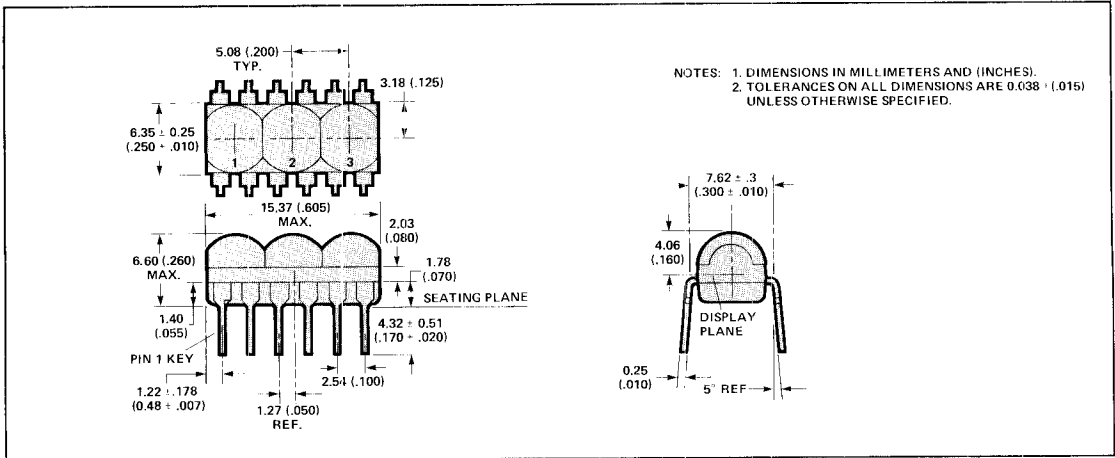

Figure 5.

Magnified Character Font Description

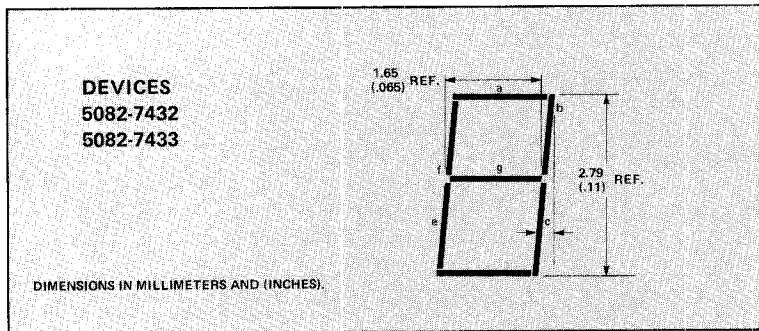

Figure 6.

Device Pin Description

PIN NUMBER	5082-7432 FUNCTION	5082-7433 FUNCTION
1	N/C	CATHODE 1
2	ANODE e	ANODE e
3	ANODE d	ANODE d
4	CATHODE 2	CATHODE 2
5	ANODE c	ANODE c
6	ANODE dp	ANODE dp
7	CATHODE 3	CATHODE 3
8	ANODE b	ANODE b
9	ANODE g	ANODE g
10	ANODE a	ANODE a
11	ANODE f	ANODE f
12	N/C	N/C

Electrical/Optical

The 5082-7430 series devices utilize a monolithic GaAsP chip of 8 common cathode devices for each display digit. The segment anodes of each digit are interconnected, forming an 8 by N line array, where N is the number of characters in the display. Each chip is positioned under an integrally molded lens giving a magnified character height of 2.79mm (0.11) inches. Satisfactory viewing will be realized within an angle of approximately $\pm 20^\circ$ from the center-line of the digit.

To improve display contrast, the plastic encapsulant contains a red dye to reduce the reflected ambient light. An additional filter, such as Plexiglass 2423, Panelgraphic 60 or 63, and Homalite 100-1600, will further lower the ambient reflectance and improve display contrast.

Character encoding on the 5082-7430 series devices is performed by standard 7 segment decoder/driver circuits. Through the use of strobing techniques

only one decoder/driver is required for very long multidigit displays.

A discussion of display circuits and drive techniques appears in Application Note 946.

Mechanical

The 5082-7430 series package is a standard 12 Pin DIP consisting of a plastic encapsulated lead frame with integrally molded lenses. It is designed for plugging into DIP sockets or soldering into PC boards. Alignment problems are simplified due to the clustering of digits in a single package.

The devices can be soldered for up to 3 seconds at a maximum solder temperature of 230°C ($1/16''$ below the seating plane). The plastic encapsulant used in these displays may be damaged by some solvents commonly used for flux removal. It is recommended that only Freon TE, Freon TE-35, Freon TF, Isopropanol, or soap and water be used for cleaning operations.

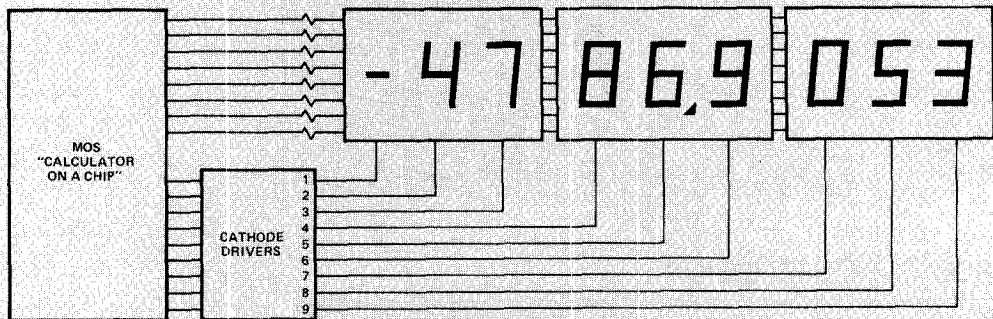

Figure 7. Block Diagram for Calculator Display