

# $\mu$ A760 High Speed Differential Comparator

Linear Division Comparators

## Description

The  $\mu$ A760 is a differential voltage comparator offering considerable speed improvement over the  $\mu$ A710 family and operates from symmetric supplies of  $\pm 4.5$  V to  $\pm 6.5$  V. The  $\mu$ A760 can be used in high speed analog-to-digital conversion systems and as a zero crossing detector in disc file and tape amplifiers. The  $\mu$ A760 output features balanced rise and fall times for minimum skew and close matching between the complementary outputs. The outputs are TTL compatible with a minimum sink capability of two gate loads.

- **Guaranteed High Speed — 25 ns Max**
- **Guaranteed Delay Matching On Both Outputs**
- **Complementary TTL Compatible Outputs**
- **High Sensitivity**
- **Standard Supply Voltages**

## Connection Diagram 14-Lead DIP (Top View)

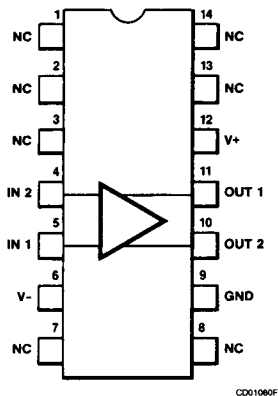

## Order Information

Device Code	Package Code	Package Description
$\mu$ A760DM	6A	Ceramic DIP
$\mu$ A760DC	6A	Ceramic DIP

## Connection Diagram 8-Lead Metal Package (Top View)

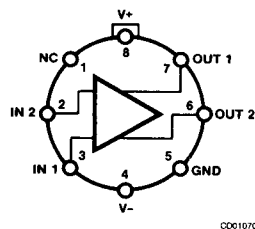

Lead 4 connected to case

## Order Information

Device Code	Package Code	Package Description
$\mu$ A760HM	5W	Metal
$\mu$ A760HC	5W	Metal

## Connection Diagram 8-Lead DIP (Top View)

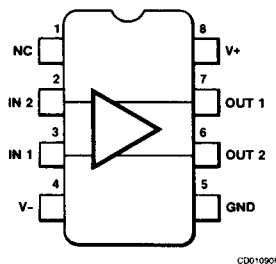

## Order Information

Device Code	Package Code	Package Description
$\mu$ A760RM	6T	Ceramic DIP
$\mu$ A760RC	6T	Ceramic DIP

# μA760

## Absolute Maximum Ratings

Storage Temperature Range	
Metal Can and Ceramic DIP	-65°C to +175°C
Molded DIP	-65°C to +150°C
Operating Temperature Range	
Extended (μA760M)	-55°C to +125°C
Commercial (μA760C)	0°C to 70°C
Lead Temperature	
Metal Can and Ceramic DIP (soldering, 60 s)	300°C
Molded DIP (soldering, 10 s)	265°C

## Internal Power Dissipation<sup>1, 2</sup>

8L-Metal Can	1.00 W
14L-Ceramic DIP	1.36 W
8L-Ceramic DIP	1.30 W
Positive Supply Voltage	+8.0 V
Negative Supply Voltage	-8.0 V
Peak Output Current	10 mA
Differential Input Voltage	±5.0 V
Input Voltage	$V+ \geq V_i \geq V-$

## Notes

- $T_{J \text{ Max}} = 175^\circ\text{C}$ .
- Ratings apply to ambient temperature at 25°C. Above this temperature, derate the 8L-Metal Can at 6.7 mW/°C, the 14L-Ceramic DIP at 9.1 mW/°C, and the 8L-Ceramic DIP at 8.7 mW/°C.

## Equivalent Circuit

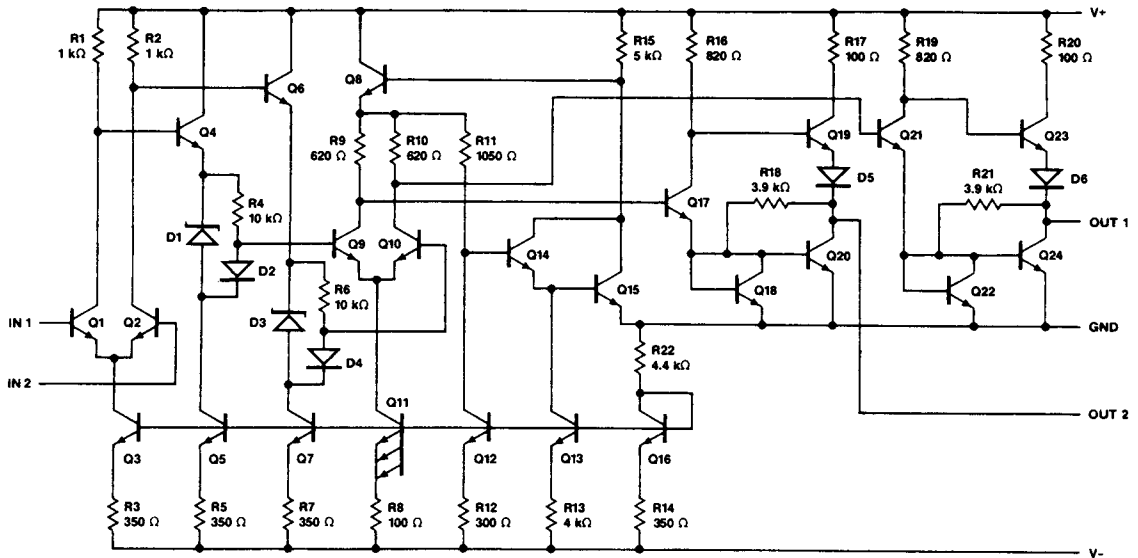

EQ00420F

# μA760

## μA760

**Electrical Characteristics**  $V_{CC} = \pm 4.5 \text{ V to } \pm 6.5 \text{ V}$ ,  $T_A = -55^\circ\text{C to } +125^\circ\text{C}$ ,  $T_A = 25^\circ\text{C}$  for typical figures, unless otherwise specified.

Symbol	Characteristic	Condition	Min	Typ	Max	Unit
$V_{IO}$	Input Offset Voltage	$R_S \leq 200 \ \Omega$		1.0	6.0	mV
$I_{IO}$	Input Offset Current			0.5	7.5	μA
$I_{IB}$	Input Bias Current			8.0	60	μA
$R_O$	Output Resistance (either output)	$V_O = V_{OH}$		100		Ω
$t_{PD}$	Response Time	$T_A = 25^\circ\text{C}^1$		18	30	ns
		$T_A = 25^\circ\text{C}^2$			25	
		(Note 3)		16		
$\Delta t_{PD}$	Response Time Difference between Outputs <sup>1</sup> ( $t_{PD}$ of $+V_{I1}$ ) - ( $t_{PD}$ of $-V_{I2}$ )	$T_A = 25^\circ\text{C}$			5.0	ns
		$T_A = 25^\circ\text{C}$			5.0	
		$T_A = 25^\circ\text{C}$			7.5	
		$T_A = 25^\circ\text{C}$			7.5	
$R_I$	Input Resistance	$f = 1.0 \text{ MHz}$		12		kΩ
$C_I$	Input Capacitance	$f = 1.0 \text{ MHz}$		8.0		pF
$\Delta V_{IO}/\Delta T$	Average Temperature Coefficient of Input Offset Voltage	$R_S = 50 \ \Omega$ , $T_A = -55^\circ\text{C to } +125^\circ\text{C}$		3.0		μV/°C
$\Delta I_{IO}/\Delta T$	Average Temperature Coefficient of Input Offset Current	$T_A = 25^\circ\text{C to } 125^\circ\text{C}$		2.0		nA/°C
		$T_A = +25^\circ\text{C to } -55^\circ\text{C}$		7.0		
$V_{IR}$	Input Voltage Range	$V_{CC} = \pm 6.5 \text{ V}$	± 4.0	± 4.5		V
$V_{IDR}$	Differential Input Voltage Range			± 5.0		V
$V_{OH}$	Output Voltage HIGH (either output)	$0 \text{ mA} \leq I_{OH} \leq 5.0 \text{ mA}$ $V_{CC} = +5.0 \text{ V}$	2.4	3.2		V
		$I_{OH} = 80 \ \mu\text{A}$ , $V_{CC} = \pm 4.5 \text{ V}$	2.4	3.0		
$V_{OL}$	Output Voltage LOW (either output)	$I_{OL} = 3.2 \text{ mA}$		0.25	0.4	V
I+	Positive Supply Current	$V_{CC} = \pm 6.5 \text{ V}$		18	32	mA
I-	Negative Supply Current	$V_{CC} = \pm 6.5 \text{ V}$		9.0	16	mA

### Notes

- Response time measured from the 50% point of a 30 mVp-p 10 MHz sinusoidal input to the 50% point of the output.
- Response time measured from the 50% point of a 2.0 V p-p 10 MHz sinusoidal input to the 50% point of the output.
- Response time measured from the start of a 100 mV input step with 5.0 mV overdrive to the time when the output crosses the logic threshold.

# μA760

## μA760C

**Electrical Characteristics**  $V_{CC} = \pm 4.5 \text{ V to } \pm 6.5 \text{ V}$ ,  $T_A = 0^\circ\text{C to } 70^\circ\text{C}$ ,  $T_A = 25^\circ\text{C}$  for typical figures, unless otherwise specified.

Symbol	Characteristic	Condition	Min	Typ	Max	Unit
$V_{IO}$	Input Offset Voltage	$R_S \leq 200 \ \Omega$		1.0	6.0	mV
$I_{IO}$	Input Offset Current			0.5	7.5	μA
$I_{IB}$	Input Bias Current			8.0	60	μA
$R_O$	Output Resistance (either output)	$V_O = V_{OH}$		100		Ω
$t_{PD}$	Response Time	$T_A = 25^\circ\text{C}^1$		18	30	ns
		$T_A = 25^\circ\text{C}^2$			25	
		(Note 3)		16		
$\Delta t_{PD}$	Response Time Difference between Outputs <sup>1</sup> ( $t_{PD}$ of $+V_{I1}$ ) - ( $t_{PD}$ of $-V_{I2}$ )	$T_A = 25^\circ\text{C}$			5.0	ns
		$T_A = 25^\circ\text{C}$			5.0	
		$T_A = 25^\circ\text{C}$			10	
		$T_A = 25^\circ\text{C}$			10	
$R_I$	Input Resistance	$f = 1.0 \text{ MHz}$		12		kΩ
$C_I$	Input Capacitance	$f = 1.0 \text{ MHz}$		8.0		pF
$\Delta V_{IO}/\Delta T$	Average Temperature Coefficient of Input Offset Voltage	$R_S = 50 \ \Omega$ , $T_A = 0^\circ\text{C to } 70^\circ\text{C}$		3.0		μV/°C
$\Delta I_{IO}/\Delta T$	Average Temperature Coefficient of Input Offset Current	$T_A = 25^\circ\text{C to } 70^\circ\text{C}$		5.0		nA/°C
		$T_A = 25^\circ\text{C to } 0^\circ\text{C}$		10		
$V_{IR}$	Input Voltage Range	$V_{CC} = \pm 6.5 \text{ V}$	± 4.0	± 4.5		V
$V_{IDR}$	Differential Input Voltage Range			± 5.0		V
$V_{OH}$	Output Voltage HIGH (either output)	$0 \text{ mA} \leq I_{OH} \leq 5.0 \text{ mA}$ $V_{CC} = +5.0 \text{ V}$	2.4	3.2		V
		$I_{OH} = 80 \ \mu\text{A}$ , $V_{CC} = \pm 4.5 \text{ V}$	2.5	3.0		
$V_{OL}$	Output Voltage LOW (either output)	$I_{OL} = 3.2 \text{ mA}$		0.25	0.4	V
I+	Positive Supply Current	$V_{CC} = \pm 6.5 \text{ V}$		18	34	mA
I-	Negative Supply Current	$V_{CC} = \pm 6.5 \text{ V}$		9.0	16	mA

### Notes

- Response time measured from the 50% point of a 30 mVp-p 10 MHz sinusoidal input to the 50% point of the output.
- Response time measured from the 50% point of a 2.0 V p-p 10 MHz sinusoidal input to the 50% point of the output.
- Response time measured from the start of a 100 mV input step with 5.0 mV overdrive to the time when the output crosses the logic threshold.

Typical Performance Curves

Response Time for Various Input Overdrives

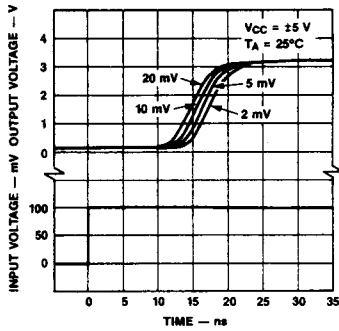

PC07300F

Response Time for Various Input Overdrives

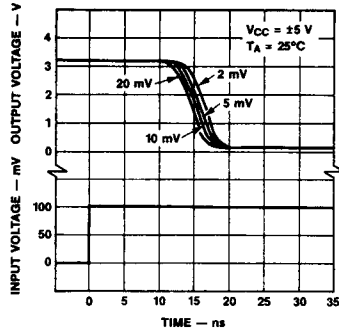

PC07310F

Response Time vs Input Voltage

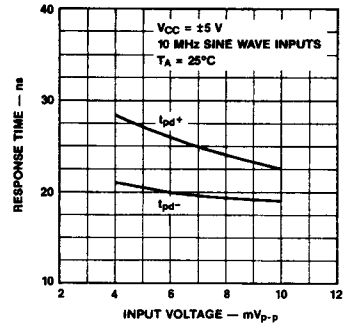

PC07320F

Response Time vs Input Voltage

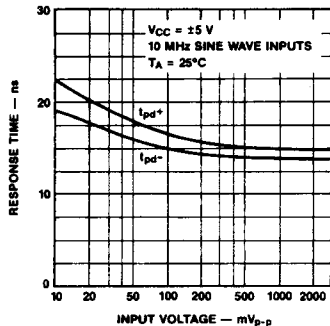

PC07330F

Voltage Transfer Characteristic

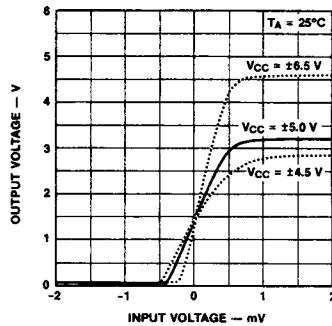

PC07340F

Voltage Transfer Characteristic

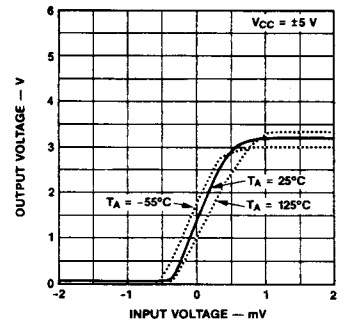

PC07350F

Voltage Gain vs Supply Voltage

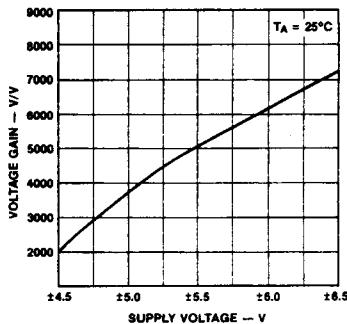

PC07361F

Voltage Gain vs Temperature

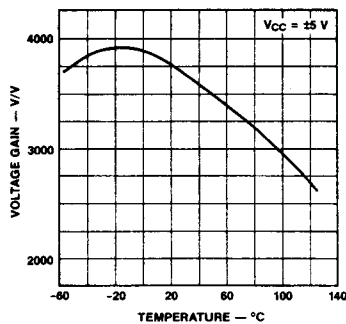

PC07370F

Input Bias Current vs Temperature

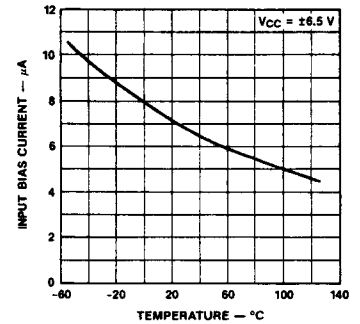

PC07380F

Typical Performance Curves (Cont.)

Input Offset Current vs Temperature

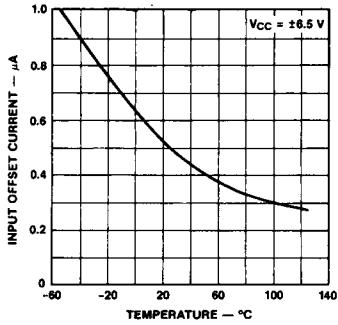

PC07390F

Response Time vs Temperature

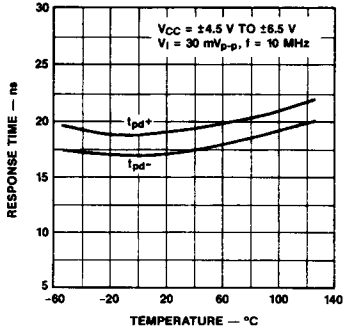

PC07401F

Output Voltage Levels vs Temperature

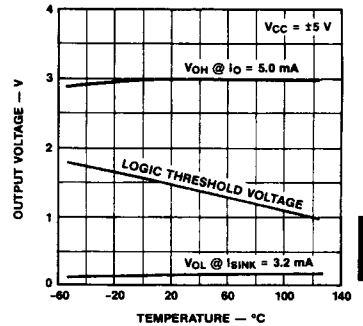

PC07411F

8

Rise Time vs Capacitive Load

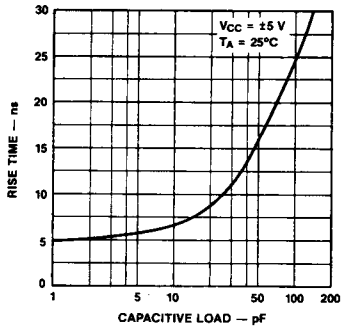

PC07420F

Fall Time vs Capacitive Load

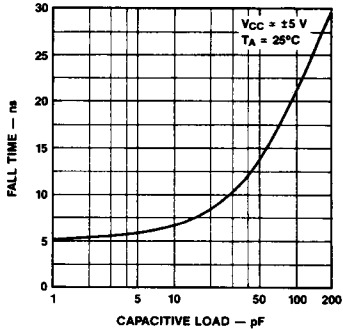

PC07430F

Input Bias Current vs Differential Input Voltage

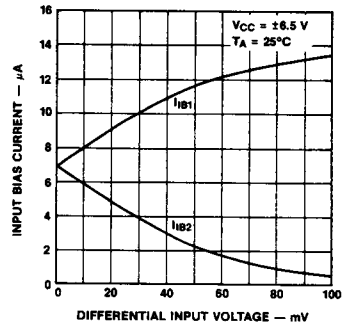

PC07440F

Common Mode Range vs Supply Voltage

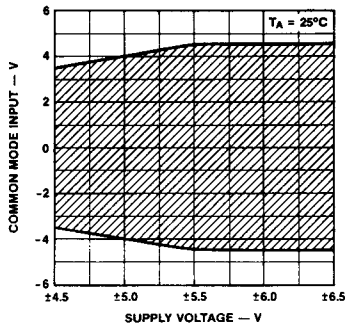

PC07450F

# μA760

## Typical Applications (Note 1)

### Fast Positive Peak Detector

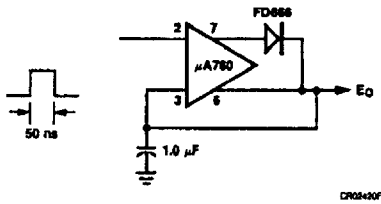

### Level Detector with Hysteresis

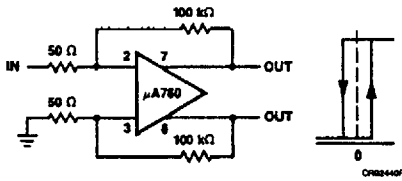

### Zero Crossing Detector (Note 2)

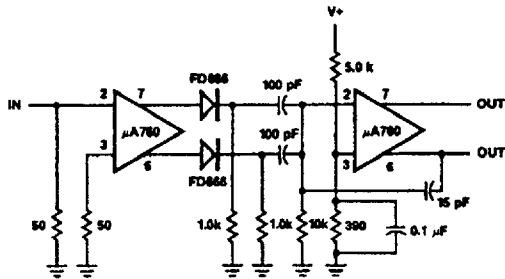

Total delay = 30 ns  
 Input frequency = 300 Hz to 3.0 MHz  
 Minimum input voltage = 20 mV<sub>p-p</sub>

CR02460F

#### Notes

1. Lead numbers shown are for Metal Package only.
2. All resistor values in ohms.

## Line Receiver With High Common Mode Range

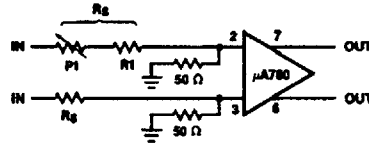

$$\text{Common mode range} = \pm 4 \times \frac{R_2}{R_1} \text{ V}$$

$$\text{Differential input sensitivity} = 5 \times \frac{R_2}{R_1} \text{ mV}$$

$R_1$  must be adjusted for optimum common mode rejection  
 For  $R_2 = 200 \Omega$   
 Common mode range =  $\pm 16 \text{ V}$   
 Sensitivity = 20 mV

## High Speed 3-Bit A/D Converter

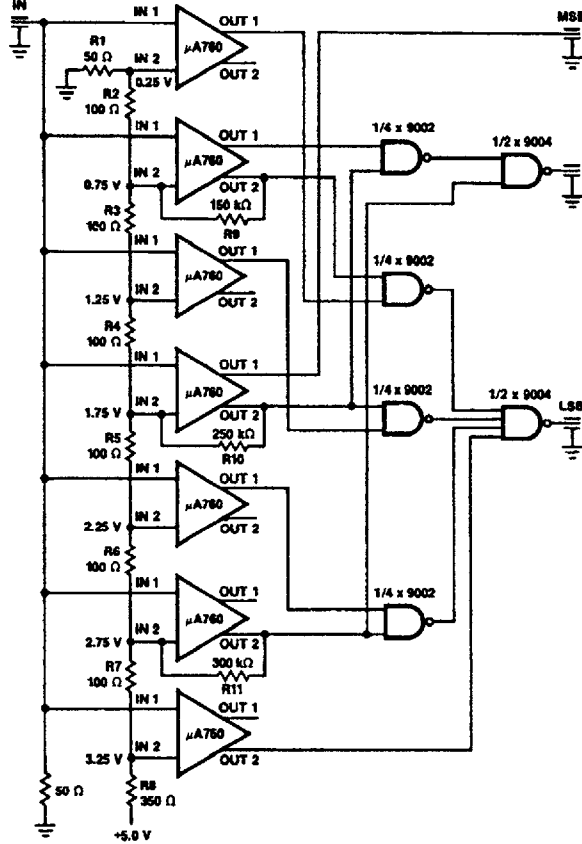

Input voltage range = 3.5 V  
 Typical conversion speed = 30 ns

CR02480F