

**DESCRIPTION**

2SC1966 is a silicon NPN epitaxial planar type transistor designed for RF power amplifiers on UHF band mobile radio applications.

**FEATURES**

- High power gain:  $G_{pe} \geq 7.8\text{dB}$   
@  $V_{CC} = 13.5\text{V}$ ,  $P_O = 3\text{W}$ ,  $f = 470\text{MHz}$
- Emitter ballasted construction and gold metallization for high reliability and good performances.
- Low thermal resistance ceramic package with flange.

**APPLICATION**

1 to 2 watts output power amplifiers in UHF band mobile radio applications.

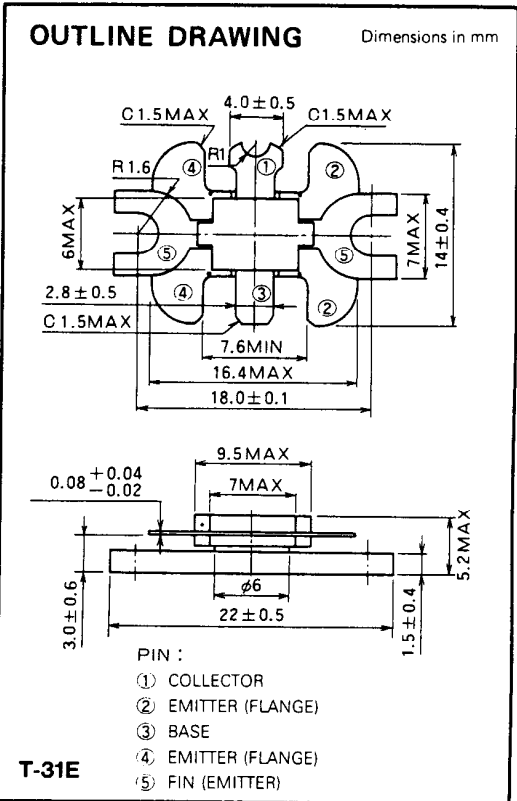

**ABSOLUTE MAXIMUM RATINGS** ( $T_C = 25^\circ\text{C}$  unless otherwise specified)

Symbol	Parameter	Conditions	Ratings	Unit
$V_{CBO}$	Collector to base voltage		35	V
$V_{EBO}$	Emitter to base voltage		3.5	V
$V_{CEO}$	Collector to emitter voltage	$R_{BE} = \infty$	17	V
$I_C$	Collector current		1	A
$P_C$	Collector dissipation	$T_C = 25^\circ\text{C}$	10	W
$T_J$	Junction temperature		175	$^\circ\text{C}$
$T_{stg}$	Storage temperature		-55 to 175	$^\circ\text{C}$
$R_{th-c}$	Thermal resistance	Junction to case	15	$^\circ\text{C/W}$

Note. Above parameters are guaranteed independently.

**ELECTRICAL CHARACTERISTICS** ( $T_C = 25^\circ\text{C}$  unless otherwise specified)

Symbol	Parameter	Test conditions	Limits			Unit
			Min	Typ	Max	
$V_{(BR)EBO}$	Emitter to base breakdown voltage	$I_F = 1\text{mA}$ , $I_C = 0$	3.5			V
$V_{(BR)CBO}$	Collector to base breakdown voltage	$I_C = 10\text{mA}$ , $I_E = 0$	35			V
$V_{(BR)CEO}$	Collector to emitter breakdown voltage	$I_C = 10\text{mA}$ , $R_{BE} = \infty$	17			V
$I_{CBO}$	Collector cutoff current	$V_{CB} = 15\text{V}$ , $I_E = 0$			100	$\mu\text{A}$
$I_{EBO}$	Emitter cutoff current	$V_{EB} = 2.5\text{V}$ , $I_C = 0$			100	$\mu\text{A}$
$h_{FE}$	DC forward current gain*	$V_{CE} = 10\text{V}$ , $I_C = 0.1\text{A}$	10	50	180	—
* $P_O$	Output power	$V_{CC} = 13.5\text{V}$ , $P_{in} = 0.5\text{W}$ , $f = 470\text{MHz}$	3	3.5		W
$\eta_C$	Collector efficiency		50	60		%

Note. \* Pulse test,  $P_W = 150\mu\text{s}$ , duty=5%.

Above parameters, ratings, limits and conditions are subject to change.

**TEST CIRCUIT**

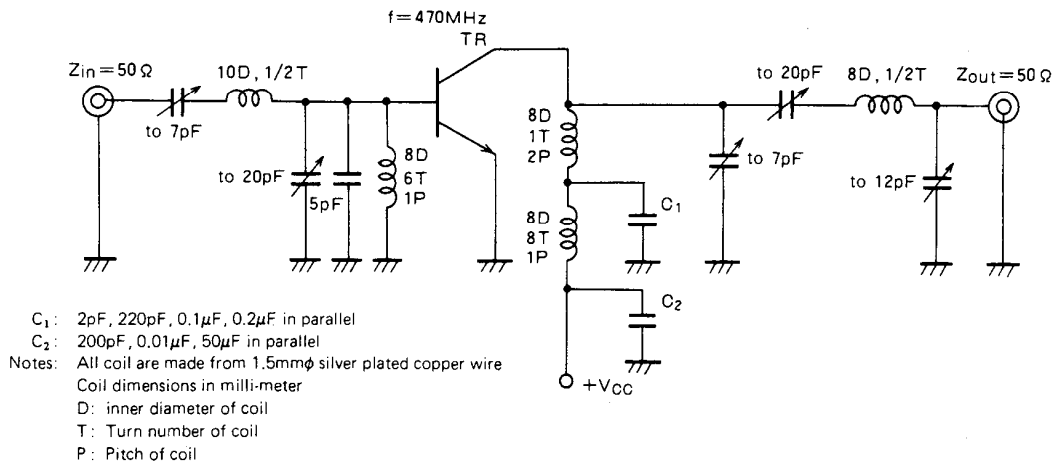

**TYPICAL PERFORMANCE DATA**

**COLLECTOR DISSIPATION VS. AMBIENT TEMPERATURE**

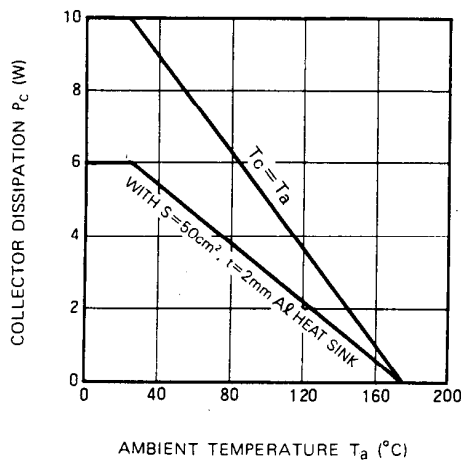

**COLLECTOR CURRENT VS. COLLECTOR TO EMITTER VOLTAGE**

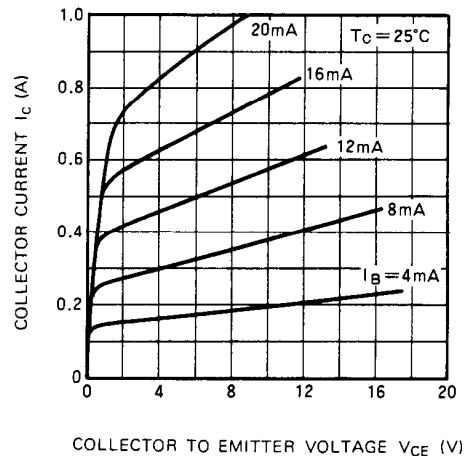

**DC CURRENT GAIN VS. COLLECTOR CURRENT**

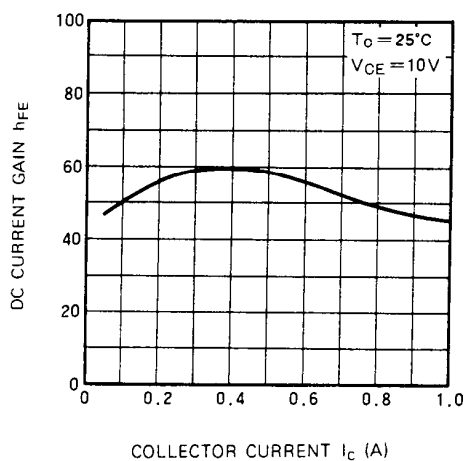

**COLLECTOR TO EMITTER BREAKDOWN VOLTAGE VS. BASE TO EMITTER RESISTANCE**

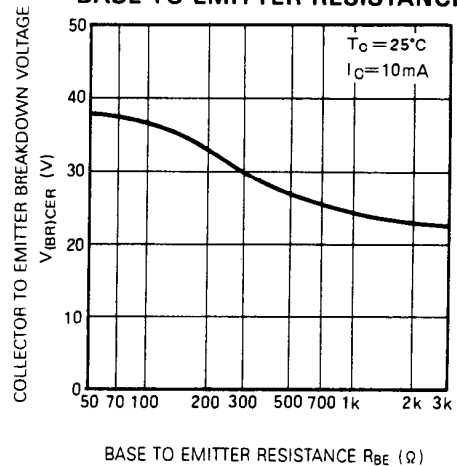

**NPN EPITAXIAL PLANAR TYPE**

**COLLECTOR OUTPUT CAPACITANCE VS. COLLECTOR TO BASE VOLTAGE**

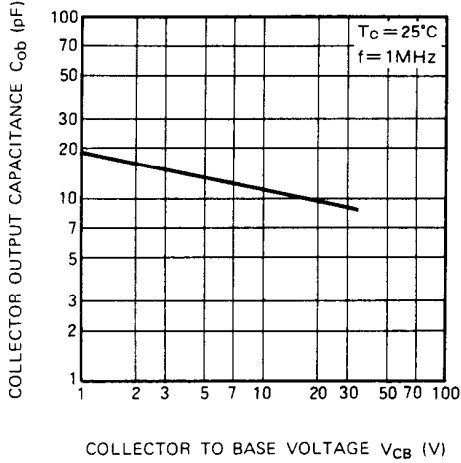

**OUTPUT POWER, COLLECTOR EFFICIENCY VS. INPUT POWER**

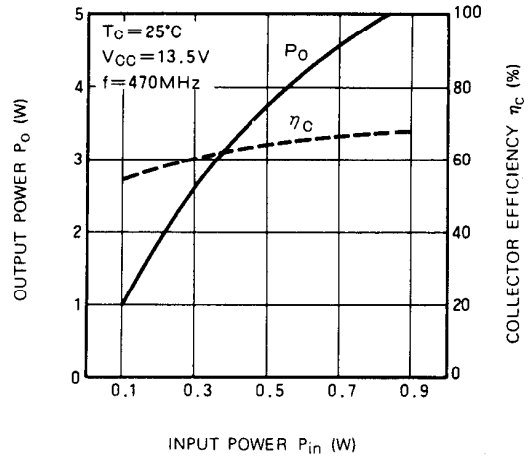

**OUTPUT POWER VS. COLLECTOR SUPPLY VOLTAGE**

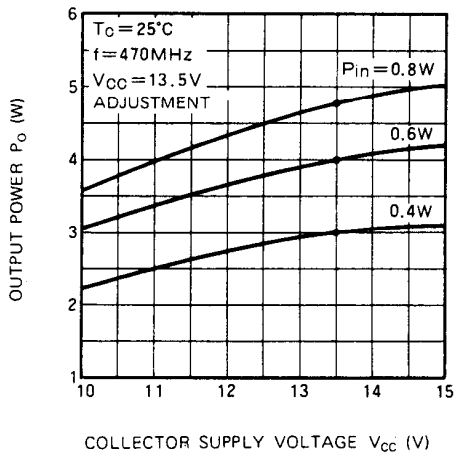

This datasheet has been download from:

[www.datasheetcatalog.com](http://www.datasheetcatalog.com)

Datasheets for electronics components.