

DATA SHEET

2N3553

Silicon planar epitaxial
overlay transistor

Product specification
Supersedes data of October 1981
File under Discrete Semiconductors, SC08a

1995 Oct 27

Silicon planar epitaxial overlay transistor

2N3553

APPLICATIONS

- The 2N3553 is intended for use in VHF and UHF transmitting applications.

DESCRIPTION

The device is a silicon NPN overlay transistor in a TO-39 metal package with the collector connected to the case.

PINNING - TO-39/3

PIN	DESCRIPTION
1	emitter
2	base
3	collector

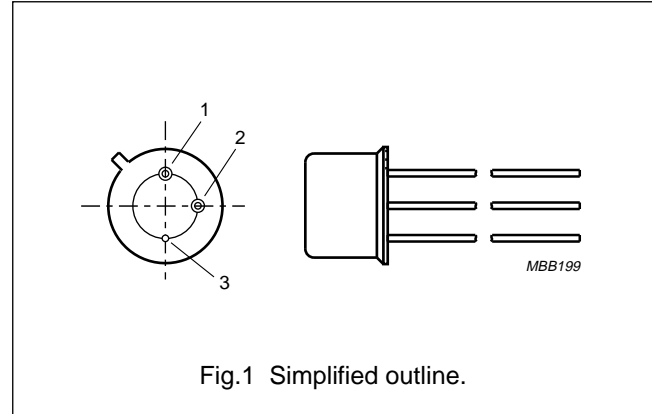

Fig.1 Simplified outline.

QUICK REFERENCE DATA

SYMBOL	PARAMETER	CONDITIONS	MAX.	UNIT
V_{CEX}	collector-emitter voltage	$I_C \leq 200 \text{ mA}$; $V_{BE} = -1.5 \text{ V}$	65	V
V_{CEO}	collector-emitter voltage	open base; $I_C \leq 200 \text{ mA}$	40	V
I_{CM}	peak collector current		1.0	A
P_{tot}	total power dissipation	up to $T_{mb} = 25 \text{ }^\circ\text{C}$	7.0	W
T_j	junction temperature		200	$^\circ\text{C}$
f_T	transition frequency	$I_C = 125 \text{ mA}$; $V_{CE} = 28 \text{ V}$	500	—

RF performance

f (MHz)	V_{CE} (V)	P_o (W)	G_p (dB)	η (%)
175	28	2.5	>10	>50

WARNING

Product and environmental safety - toxic materials

This product contains beryllium oxide. The product is entirely safe provided that the BeO disc is not damaged. All persons who handle, use or dispose of this product should be aware of its nature and of the necessary safety precautions. After use, dispose of as chemical or special waste according to the regulations applying at the location of the user. It must never be thrown out with the general or domestic waste.

Silicon planar epitaxial overlay transistor

2N3553

LIMITING VALUES

In accordance with the Absolute Maximum Rating System (IEC 134).

SYMBOL	PARAMETER	CONDITIONS	MIN.	MAX.	UNIT
V_{CBO}	collector-base voltage	open emitter	–	65	V
V_{CEX}	collector-emitter voltage	$I_C \leq 200 \text{ mA}$; $V_{BE} = -1.5 \text{ V}$	–	65	V
V_{CEO}	collector-emitter voltage	open base; $I_C \leq 200 \text{ mA}$	–	40	V
V_{EBO}	emitter-base voltage	open collector	–	4	V
I_C	collector current (DC)		–	0.35	A
I_{CM}	peak collector current		–	1	A
P_{tot}	total power dissipation	up to $T_{mb} = 25 \text{ }^\circ\text{C}$	–	7	W
T_{stg}	storage temperature		–65	+200	$^\circ\text{C}$
T_j	junction temperature		–	200	$^\circ\text{C}$

THERMAL CHARACTERISTICS

SYMBOL	PARAMETER	VALUE	UNIT
$R_{th \text{ j-mb}}$	thermal resistance from junction to mounting base	25	K/W

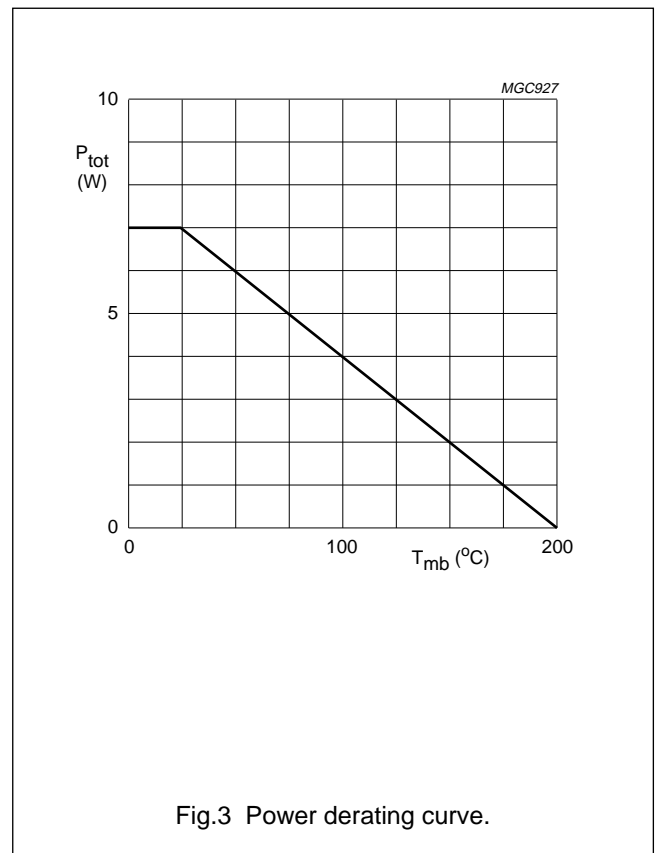
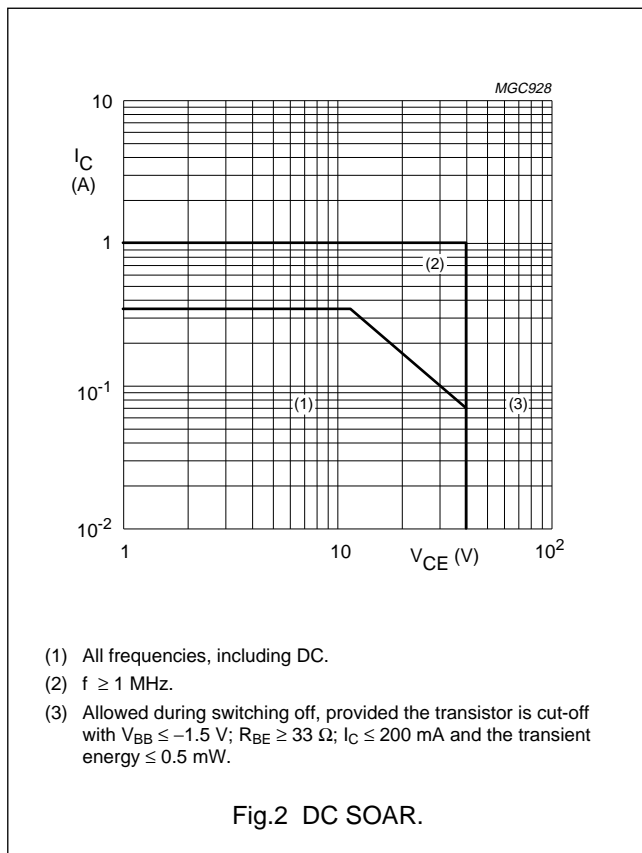

Silicon planar epitaxial
overlay transistor

2N3553

CHARACTERISTICS

$T_j = 25\text{ }^\circ\text{C}$ unless otherwise specified.

SYMBOL	PARAMETER	CONDITIONS	MIN.	TYP.	MAX.	UNIT
$V_{(BR)CBO}$	collector-base breakdown voltage	open emitter; $I_C = 0.25\text{ mA}$	65	–	–	V
$V_{(BR)CEO}$	collector-emitter breakdown voltage	open base; I_C up to 200 mA; note 1	40	–	–	V
$V_{(BR)CEX}$	collector-emitter breakdown voltage	I_C up to 200 mA; $V_{BE} = -1.5\text{ V}$; $R_B = 33\ \Omega$; note 1	65	–	–	V
$V_{(BR)EBO}$	emitter-base breakdown voltage	open collector; $I_E = 0.25\text{ mA}$	4	–	–	V
V_{BE}	base-emitter voltage	$I_C = 250\text{ mA}$; $V_{CE} = 5\text{ V}$	–	–	1.5	V
V_{CEsat}	collector-emitter saturation voltage	$I_C = 250\text{ mA}$; $I_B = 50\text{ mA}$	–	–	1.0	V
I_{CEO}	collector leakage current	open base; $V_{CE} = 30\text{ V}$	–	–	0.1	mA
h_{FE}	DC current gain	$V_{CE} = 5\text{ V}$; $I_C = 125\text{ mA}$	15	–	200	
		$V_{CE} = 5\text{ V}$; $I_C = 250\text{ mA}$	10	–	100	
f_T	transition frequency	$I_C = 125\text{ mA}$; $V_{CE} = 28\text{ V}$	–	500	–	MHz
Rho_{ie}	real part of input impedance	$I_C = 125\text{ mA}$; $V_{CE} = 28\text{ V}$; $f = 200\text{ MHz}$	–	–	20	Ω
C_c	collector capacitance	$V_{CB} = 28\text{ V}$; $I_E = i_e = 0$; $f = 1\text{ MHz}$	–	–	10	pF

Note

1. Pulsed through an inductor of 25 mH; $\delta = 0.5$; $f = 50\text{ Hz}$.

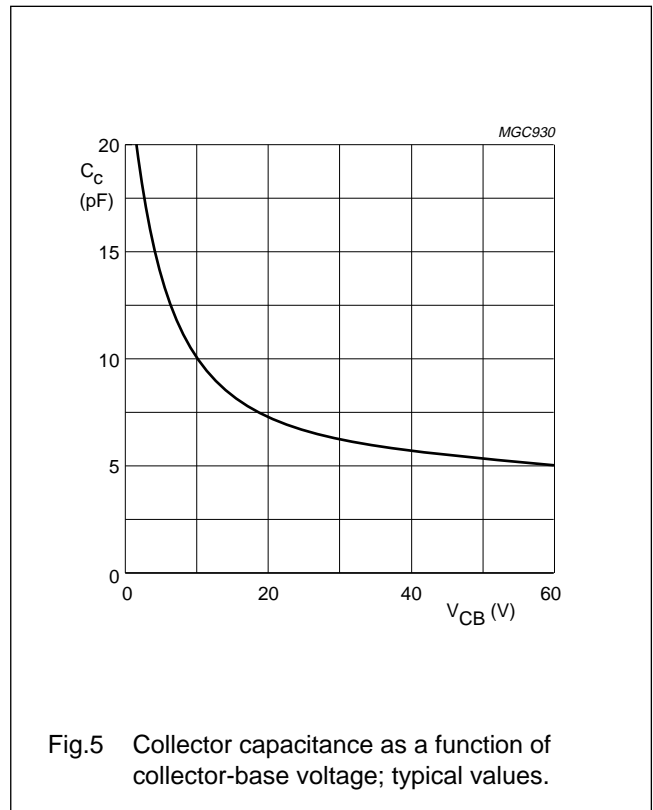
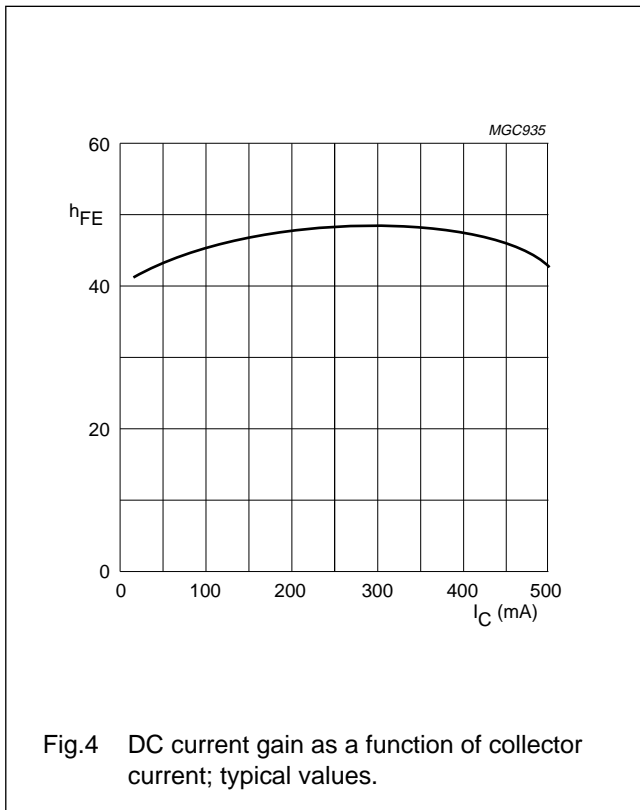

Silicon planar epitaxial
overlay transistor

2N3553

APPLICATION INFORMATION

RF performance at $T_{mb} = 25\text{ }^{\circ}\text{C}$.

f (MHz)	V_{CE} (V)	P_o (W)	G_p (dB)	η (%)
175	28	2.5	>10	>50

Ruggedness

The transistor is capable of withstanding a load mismatch corresponding to $VSWR = 3 : 1$ varied through all phases, under the conditions: $V_{CE} = 28\text{ V}$; $f = 175\text{ MHz}$; $T_{mb} = 25\text{ }^{\circ}\text{C}$; $P_o = 2.5\text{ W}$.

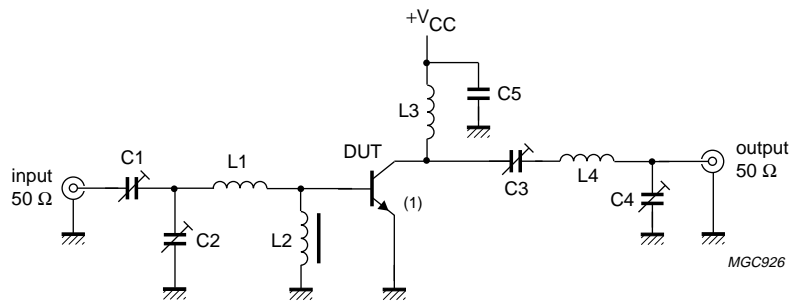

(1) The length of the external emitter wire is 1.6 mm.

Fig.6 Test circuit at 175 MHz.

Silicon planar epitaxial
overlay transistor

2N3553

List of components (see Fig.6)

COMPONENT	DESCRIPTION	VALUE	DIMENSIONS	CATALOGUE No.
C1, C2, C3, C4	air trimmer capacitor	4 to 29 pF		
C5	polyester capacitor	10 nF		
L1	1 turn 1.0 mm copper wire		int. diameter 10 mm; leads 2 × 10 mm	
L2	Ferroxcube choke coil	Z = 550 Ω ±20%; f = 175 MHz		4312 020 36640
L3	15 turns enamelled 0.7 mm copper wire		int. diameter 4 mm; closely wound	
L4	3 turns enamelled 1.5 mm copper wire		int. diameter 12 mm; leads 2 × 20 mm; closely wound	

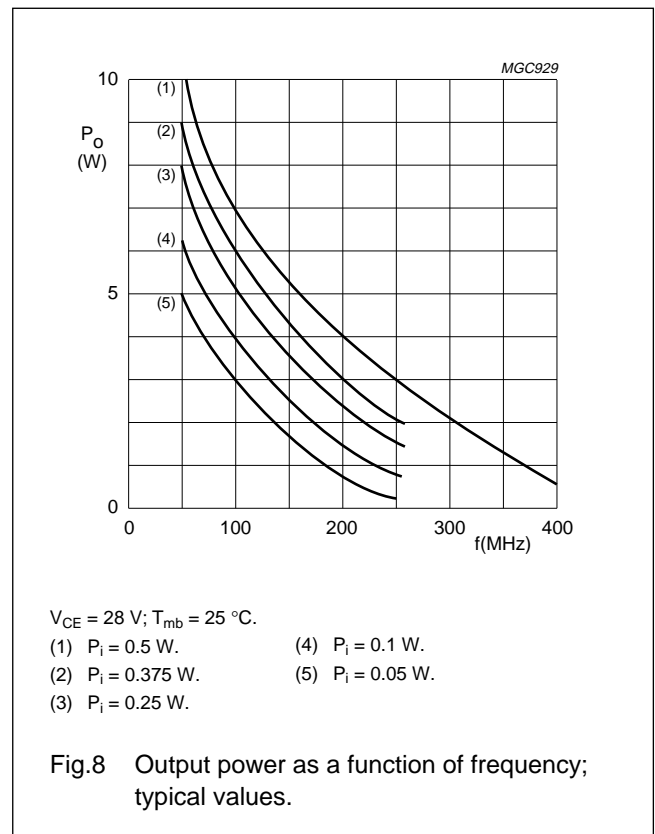
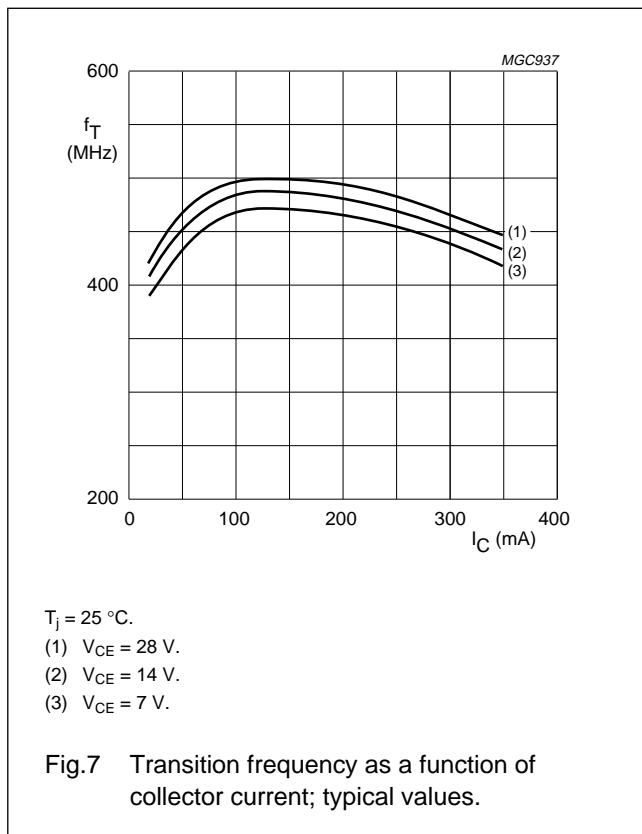

Silicon planar epitaxial
overlay transistor

2N3553

PACKAGE OUTLINE

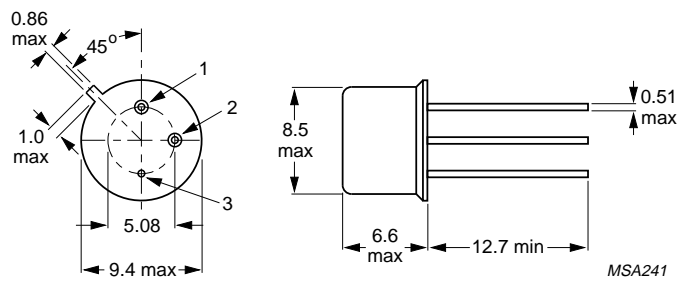

Dimensions in mm.

Fig.9 TO-39.

**Silicon planar epitaxial
overlay transistor**

2N3553**DEFINITIONS**

Data Sheet Status	
Objective specification	This data sheet contains target or goal specifications for product development.
Preliminary specification	This data sheet contains preliminary data; supplementary data may be published later.
Product specification	This data sheet contains final product specifications.
Limiting values	
Limiting values given are in accordance with the Absolute Maximum Rating System (IEC 134). Stress above one or more of the limiting values may cause permanent damage to the device. These are stress ratings only and operation of the device at these or at any other conditions above those given in the Characteristics sections of the specification is not implied. Exposure to limiting values for extended periods may affect device reliability.	
Application information	
Where application information is given, it is advisory and does not form part of the specification.	

LIFE SUPPORT APPLICATIONS

These products are not designed for use in life support appliances, devices, or systems where malfunction of these products can reasonably be expected to result in personal injury. Philips customers using or selling these products for use in such applications do so at their own risk and agree to fully indemnify Philips for any damages resulting from such improper use or sale.