

8 mm (0.31 inch) Ultra Mini Seven Segment Displays

Technical Data

HDSP-U0XX Series
HDSP-U1XX Series
HDSP-U2XX Series
HDSP-U3XX Series
HDSP-U4XX Series
HDSP-U5XX Series

Features

- **Compact Package**
- **8 mm (0.31 inch) Character Height**
- **Choice of Colors**
Wide Range of Colors
- **Excellent Appearance**
Evenly Lighted Segments
Mitered Corners on Segments
Gray/Black Surface Gives Optimum Contrast
± 50° Viewing Angle
- **Design Flexibility**
Common Anode or Common Cathode
Right Hand Decimal Point
- **Categorized for Luminous Intensity**
Yellow and Green also Categorized for Color
Use of Like Categories Yields a Uniform Display

- **High Light Output**
- **High Peak Current**
- **Excellent for Long Digit String Multiplexing**
- **Intensity and Color Selection Option**

Description

The 8 mm (0.31 inch) LED seven segment displays are HP's most space-efficient character size. They are designed for viewing distances up to 3 metres (10 feet). The numeric devices feature a right hand decimal point. All devices are available as either common anode or common cathode.

Typical applications include appliances, temperature controllers, and digital panel meters.



Devices

| Red HDSP- | AlGaAs Red HDSP- | HER HDSP- | Orange HDSP- | Yellow HDSP- | Green HDSP- | Description | Circuit Diagram |
|-----------|------------------|-----------|--------------|--------------|-------------|---|-----------------|
| U001 | U101 | U201 | U401 | U301 | U501 | Common Anode, Right Hand Decimal, Gray Surface | A |
| U003 | U103 | U203 | U403 | U303 | U503 | Common Cathode, Right Hand Decimal, Gray Surface | B |
| U011 | U111 | U211 | U411 | U311 | U511 | Common Anode, Right Hand Decimal, Black Surface | A |
| U013 | U113 | U213 | U413 | U313 | U513 | Common Cathode, Right Hand Decimal, Black Surface | B |

Package Dimensions

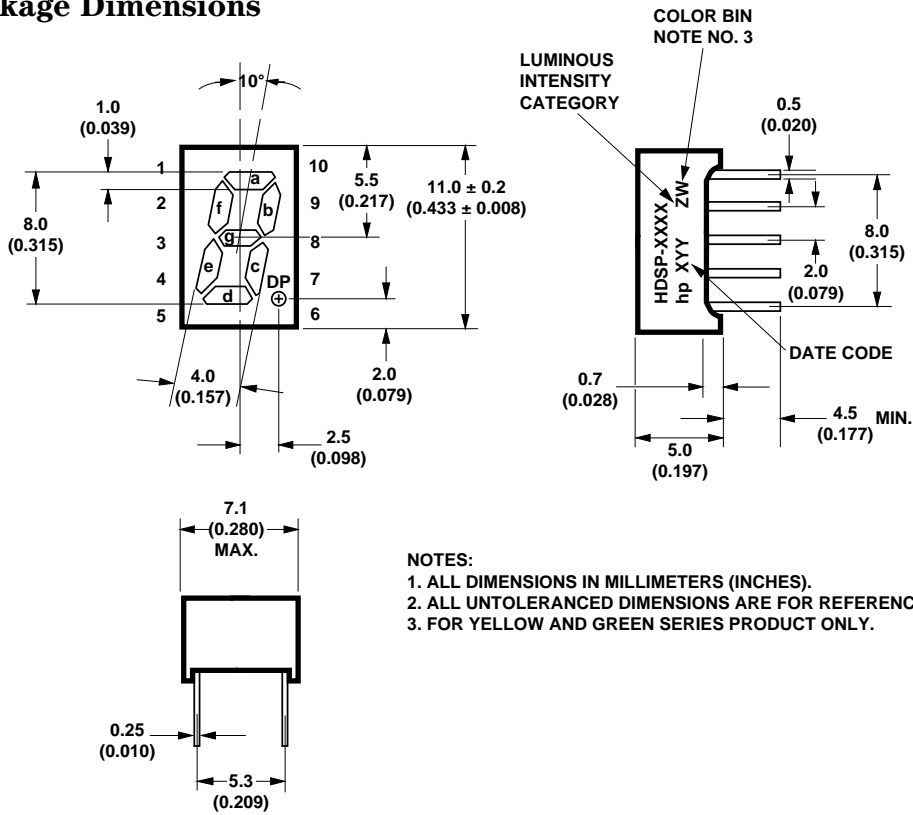

- NOTES:**
1. ALL DIMENSIONS IN MILLIMETERS (INCHES).
 2. ALL UNTOLERANCED DIMENSIONS ARE FOR REFERENCE ONLY.
 3. FOR YELLOW AND GREEN SERIES PRODUCT ONLY.

Internal Circuit Diagram

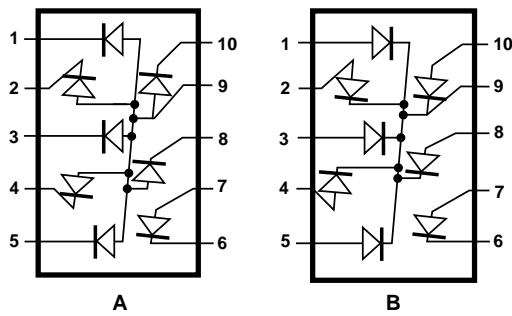

| PIN | FUNCTION | |
|-----|------------|------------|
| | A | B |
| 1 | CATHODE a | ANODE a |
| 2 | CATHODE f | ANODE f |
| 3 | CATHODE g | ANODE g |
| 4 | CATHODE e | ANODE e |
| 5 | CATHODE d | ANODE d |
| 6 | CATHODE DP | CATHODE DP |
| 7 | ANODE DP | ANODE DP |
| 8 | CATHODE c | ANODE c |
| 9 | ANODE | CATHODE |
| 10 | CATHODE b | ANODE b |

HDSP-UXXX CIRCUIT

Absolute Maximum Ratings

| Description | Red HDSP-U0XX Series | AlGaAs Red HDSP-U1XX Series | HER/Orange HDSP-U2XX/-4XX Series | Yellow HDSP-U3XX Series | Green HDSP-U5XX Series | Units |
|---|----------------------|-----------------------------|----------------------------------|-------------------------|------------------------|-------|
| Average Power per Segment or DP | 82 | 37 | 105 | 80 | 105 | mW |
| Peak Forward Current per Segment or DP | 150 ^[1] | 45 ^[3] | 90 ^[5] | 60 ^[7] | 90 ^[9] | mA |
| DC Forward Current per Segment or DP | 25 ^[2] | 15 ^[4] | 30 ^[6] | 20 ^[8] | 30 ^[10] | mA |
| Operating Temperature Range | -25 to +90 | -20 to +90 | -25 to +90 | | | °C |
| Storage Temperature Range | -30 – +90 | | | | | °C |
| Reverse Voltage per Segment or DP | 3.0 | | | | | V |
| Lead Solder Temperature for 3 Seconds (1.60 mm [0.063 in.] below seating plane) | 260 | | | | | °C |

Notes:

- See Figure 1 to establish pulsed conditions.
- Derate above 80°C at 0.63 mA/°C (see figure 3).
- See Figure 2 to establish pulsed conditions.
- No derating over specified temperature range.
- See Figure 7 to establish pulsed conditions.
- Derate above 53°C at 0.45 mA/°C (see figure 10).
- See Figure 8 to establish pulsed conditions.
- Derate above 81°C at 0.52 mA/°C (see figure 10).
- See Figure 9 to establish pulsed conditions.
- Derate above 39°C at 0.37 mA/°C (see figure 10).

Electrical/Optical Characteristics at T_A = 25°C

Red

| Device Series | Parameter | Symbol | Min. | Typ. | Max. | Units | Test Conditions |
|--|--|---------------------|------|------|--------------|-------|-------------------------|
| HDSP-U0XX | Luminous Intensity/Segment ^[1,2] (Digit Average) | I _V | 600 | 1100 | | μcd | I _F = 20 mA |
| | | | | 500 | | | I _F = 10 mA |
| | Forward Voltage/Segment or DP | V _F | | 1.6 | 2.0 | V | I _F = 20 mA |
| | Peak Wavelength | λ _{PEAK} | | 655 | | nm | |
| | Dominant Wavelength ^[3] | λ _d | | 640 | | nm | |
| | Reverse Voltage/Segment or DP ^[4] | V _R | 3.0 | 12 | | V | I _R = 100 μA |
| | Temperature Coefficient of V _F /Segment or DP | ΔV _F /°C | | -2 | | mV/°C | |
| Thermal Resistance LED Junction-to-Pin | Rθ _{J-Pin} | | 200 | | °C/W/ Seg | | |

AlGaAs Red

| Device Series | Parameter | Symbol | Min. | Typ. | Max. | Units | Test Conditions |
|---|--|-------------------------|------|------|------------------------|----------------|-------------------------|
| HDSP-U1XX | Luminous Intensity/Segment ^[1,2] (Digit Average) | I_V | 315 | 600 | | μcd | $I_F = 1 \text{ mA}$ |
| | | | | 3600 | | | $I_F = 5 \text{ mA}$ |
| | Forward Voltage/Segment or DP | V_F | | 1.6 | | V | $I_F = 1 \text{ mA}$ |
| | | | | 1.7 | | | $I_F = 5 \text{ mA}$ |
| | | | | 1.8 | 2.2 | | $I_F = 20 \text{ mA}$ |
| | Peak Wavelength | λ_{PEAK} | | 645 | | nm | |
| | Dominant Wavelength ^[3] | λ_d | | 637 | | nm | |
| | Reverse Voltage/Segment or DP ^[4] | V_R | 3.0 | 15 | | V | $I_R = 100 \mu\text{A}$ |
| Temperature Coefficient of V_F /Segment or DP | $\Delta V_F / ^\circ\text{C}$ | | -2 | | mV/ $^\circ\text{C}$ | | |
| Thermal Resistance LED Junction-to-Pin | $R\theta_{\text{J-Pin}}$ | | 255 | | $^\circ\text{C/W/Seg}$ | | |

High Efficiency Red

| Device Series | Parameter | Symbol | Min. | Typ. | Max. | Units | Test Conditions |
|--|--|-------------------------------|------|------|------------------------|----------------------|-------------------------|
| HDSP-U2XX | Luminous Intensity/Segment ^[1,2] (Digit Average) | I_V | 360 | 980 | | μcd | $I_F = 5 \text{ mA}$ |
| | | | | 5390 | | | $I_F = 20 \text{ mA}$ |
| | Forward Voltage/Segment or DP | V_F | | 2.0 | 2.5 | V | $I_F = 20 \text{ mA}$ |
| | Peak Wavelength | λ_{PEAK} | | 635 | | nm | |
| | Dominant Wavelength ^[3] | λ_d | | 626 | | nm | |
| | Reverse Voltage/Segment or DP ^[4] | V_R | 3.0 | 30 | | V | $I_R = 100 \mu\text{A}$ |
| | Temperature Coefficient of V_F /Segment or DP | $\Delta V_F / ^\circ\text{C}$ | | -2 | | mV/ $^\circ\text{C}$ | |
| Thermal Resistance LED Junction-to-Pin | $R\theta_{\text{J-Pin}}$ | | 200 | | $^\circ\text{C/W/Seg}$ | | |

Orange

| Device Series | Parameter | Symbol | Min. | Typ. | Max. | Units | Test Conditions |
|--|--|---------------------|------|------|--------------|-------|-------------------------|
| HDSP-U4XX | Luminous Intensity/Segment ^[1,2] (Digit Average) | I _V | 360 | 980 | | μcd | I _F = 5 mA |
| | | | | 5390 | | | I _F = 20 mA |
| | Forward Voltage/Segment or DP | V _F | | 2.0 | 2.5 | V | I _F = 20 mA |
| | Peak Wavelength | λ _{PEAK} | | 600 | | nm | |
| | Dominant Wavelength ^[3] | λ _d | | 603 | | nm | |
| | Reverse Voltage/Segment or DP ^[4] | V _R | 3.0 | 30 | | V | I _R = 100 μA |
| | Temperature Coefficient of V _F /Segment or DP | ΔV _F /°C | | -2 | | mV/°C | |
| Thermal Resistance LED Junction-to-Pin | Rθ _{J-Pin} | | 200 | | °C/W/ Seg | | |

Yellow

| Device Series | Parameter | Symbol | Min. | Typ. | Max. | Units | Test Conditions |
|--|--|---------------------|-------|------|--------------|-------|-------------------------|
| HDSP-U3XX | Luminous Intensity/Segment ^[1,2] (Digit Average) | I _V | 225 | 480 | | μcd | I _F = 5 mA |
| | | | | 2740 | | | I _F = 20 mA |
| | Forward Voltage/Segment or DP | V _F | | 2.2 | 2.5 | V | I _F = 20 mA |
| | Peak Wavelength | λ _{PEAK} | | 583 | | nm | |
| | Dominant Wavelength ^[3,5] | λ _d | 581.5 | 586 | 592.5 | nm | |
| | Reverse Voltage/Segment or DP ^[4] | V _R | 3.0 | 50.0 | | V | I _R = 100 μA |
| | Temperature Coefficient of V _F /Segment or DP | ΔV _F /°C | | -2 | | mV/°C | |
| Thermal Resistance LED Junction-to-Pin | Rθ _{J-Pin} | | 200 | | °C/W/ Seg | | |

High Performance Green

| Device Series | Parameter | Symbol | Min. | Typ. | Max. | Units | Test Conditions |
|--|--|---------------------|------|------|--------------|-------|-------------------------|
| HDSP-U5XX | Luminous Intensity/Segment ^[1,2] (Digit Average) | I _V | 860 | 3000 | | μcd | I _F = 10 mA |
| | | | | 6800 | | | I _F = 20 mA |
| | Forward Voltage/Segment or DP | V _F | | 2.1 | 2.5 | V | I _F = 10 mA |
| | Peak Wavelength | λ _{PEAK} | | 566 | | nm | |
| | Dominant Wavelength ^[3,5] | λ _d | | 571 | | nm | |
| | Reverse Voltage/Segment or DP ^[4] | V _R | 3.0 | 50.0 | | V | I _R = 100 μA |
| | Temperature Coefficient of V _F /Segment or DP | ΔV _F /°C | | -2 | | mV/°C | |
| Thermal Resistance LED Junction-to-Pin | Rθ _{J-Pin} | | 200 | | °C/W/ Seg | | |

Notes:

- Case temperature of device immediately prior to the intensity measurement is 25°C.
- The digits are categorized for luminous intensity. The intensity category is designated by a letter on the side of the package.
- The dominant wavelength, λ_d, is derived from the CIE chromaticity diagram and is that single wavelength which defines the color of the device.
- Typical specification for reference only. Do not exceed absolute maximum ratings.
- The Yellow (HDSP-U3XX) series and Green (HDSP-U5XX) series displays are categorized for dominant wavelength. The category is designated by a number adjacent to the luminous intensity category letter.

Red, AlGaAs Red

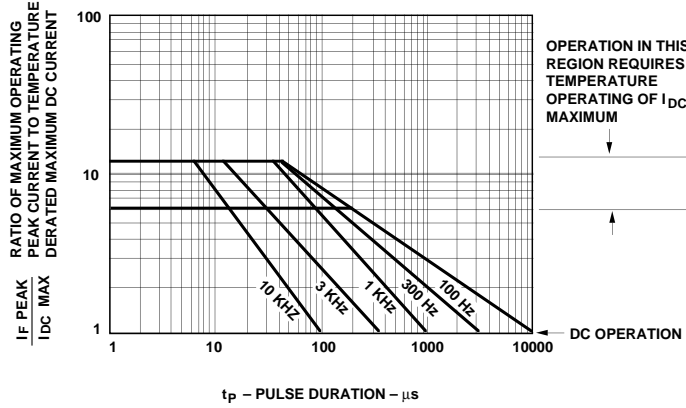

Figure 1. Maximum Tolerable Peak Current vs. Pulse Duration - Red.

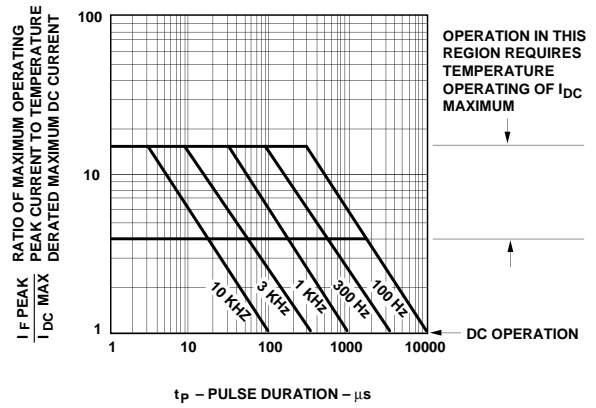

Figure 2. Maximum Tolerable Peak Current vs. Pulse Duration - AlGaAs Red.

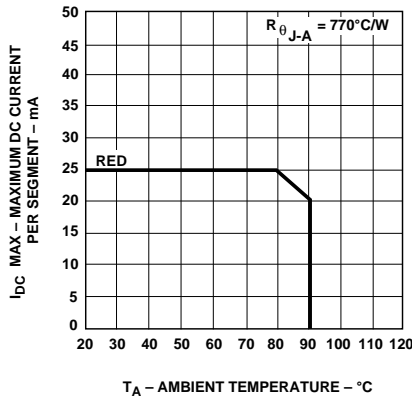

Figure 3. Maximum Allowable DC Current vs. Ambient Temperature.

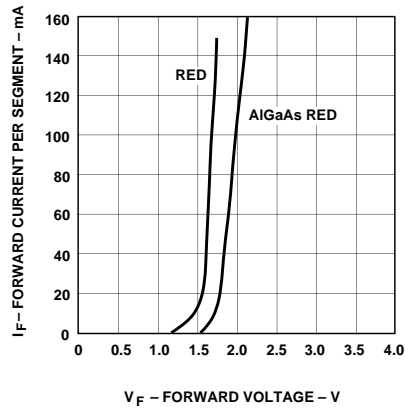

Figure 4. Forward Current vs. Forward Voltage.

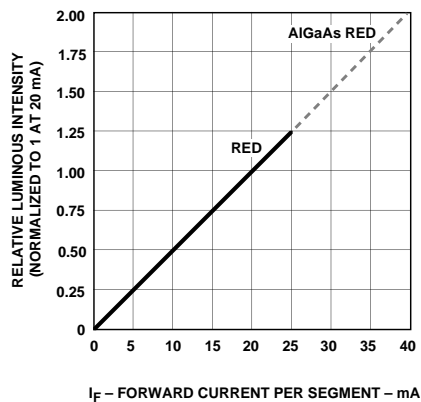

Figure 5. Relative Luminous Intensity vs. DC Forward Current.

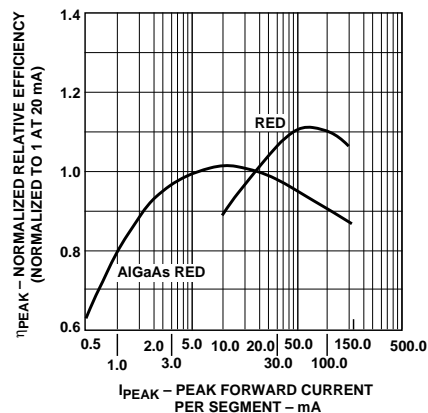

Figure 6. Relative Efficiency (Luminous Intensity per Unit Current) vs. Peak Current.

HER, Orange, Yellow, Green

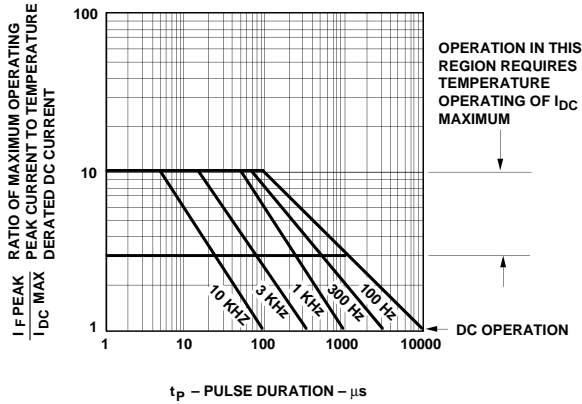

Figure 7. Maximum Tolerable Peak Current vs. Pulse Duration – HER, Orange.

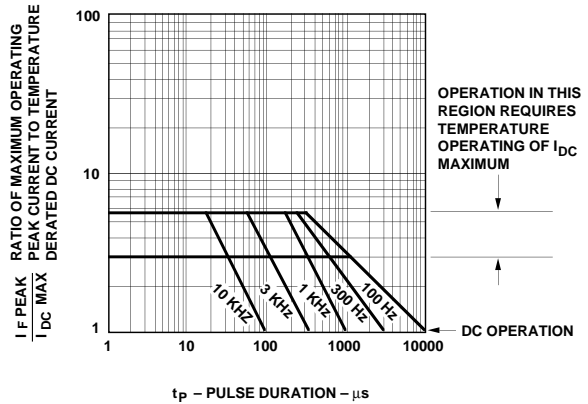

Figure 8. Maximum Tolerable Peak Current vs. Pulse Duration – Yellow.

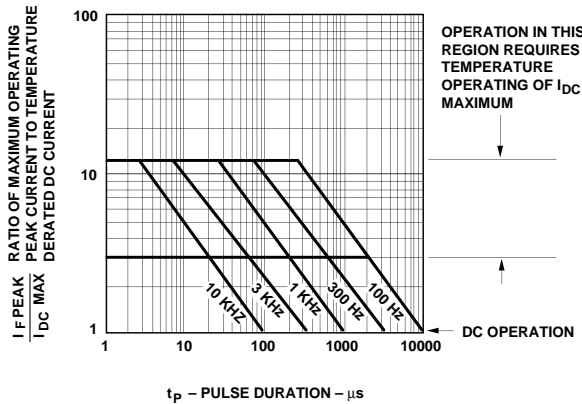

Figure 9. Maximum Tolerable Peak Current vs. Pulse Duration – Green.

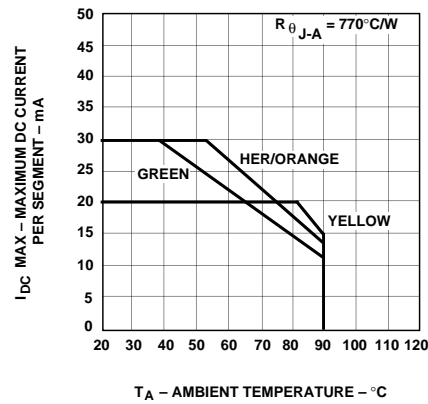

Figure 10. Maximum Allowable DC Current vs. Ambient Temperature.

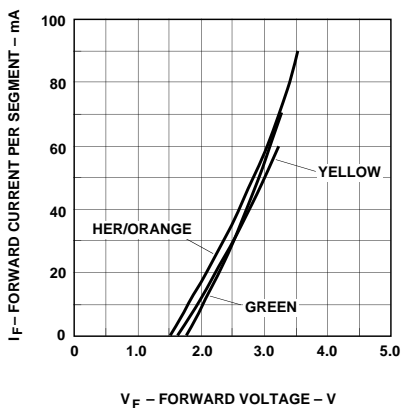

Figure 11. Forward Current vs. Forward Voltage Characteristics.

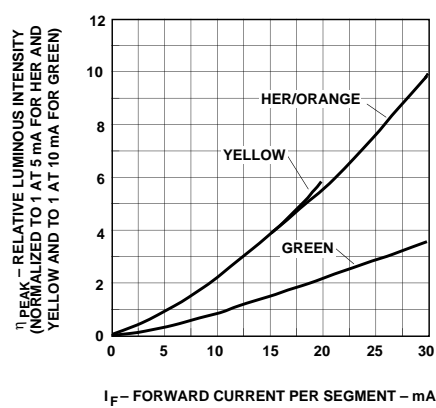

Figure 12. Relative Luminous Intensity vs. DC Forward Current.

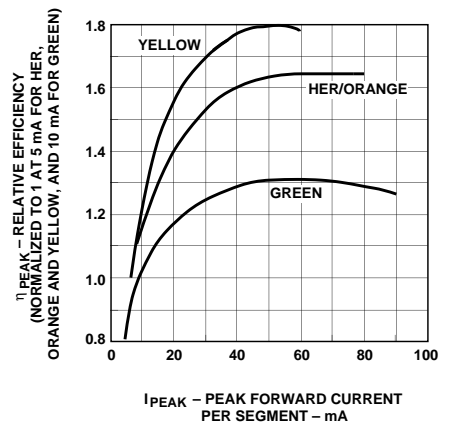

Figure 13. Relative Efficiency (Luminous Intensity per Unit Current) vs. Peak Current.

Electrical/Optical

For more information on electrical/optical characteristics, please see Application Note 1005.

Contrast Enhancement

For information on contrast enhancement please see Application Note 1015.

Soldering/Cleaning

Cleaning agents from the ketone family (acetone, methyl ethyl ketone, etc.) and from the chlorinated hydrocarbon family

(methylene chloride, trichloroethylene, carbon tetrachloride, etc.) are not recommended for cleaning LED parts. All of these various solvents attack or dissolve the encapsulating materials used to form the package of plastic LED parts.

For more information on soldering LEDs please refer to Application Note 1027.